

OPERATION MANUAL



modbus mapping 

OPERATION MANUAL

M-thermal Wired Controller



English

BEDIENUNGSHANDBUCH

M-thermal Kabelgebundene Fernbedienung



Deutsch

ÇALIŞMA KILAVUZU

M-thermal Kablolü Kumanda



Türk dili

HANDLEIDING

M-thermische bedrade controller



Nederlands

MANUAL DE UTILIZARE

Telecomandă cablată M-thermal



Roman

РУКОВОДСТВО ПО ЭКСПЛУАТАЦИИ

Проводной пульт управления M-thermal



Русский язык

Thank you very much for purchasing our product.

Before using your unit, please read this manual carefully and keep it for future reference.

- This manual gives detailed description of the precautions that should be brought to your attention during operation.
- In order to ensure correct service of the wired controller, please read this manual carefully before using the unit.
- For convenience of future reference, keep this manual after reading it.

CONTENTS

1 GENERAL SAFETY PRECAUTIONS

- 1.1 About the documentation 1
- 1.2 For the user 2

2 A GLANCE OF THE USER INTERFACE

- 2.1 The appearance of the wired controller 5
- 2.2 Status icons 6

3 USING HOME PAGES

- 3.1 About home pages 7

4 MENU STRUCTURE

- 4.1 About the menu structure 11
- 4.2 To go to the menu structure 11
- 4.3 To navigate in the menu structure 11

5 BASIC USAGE

- 5.1 Screen unlock 12
- 5.2 Turning ON/OFF controls 14
- 5.3 Adjusting the temperature 19
- 5.4 Adjusting space operation mode 22

6 NETWORK CONFIGURATION GUIDELINES

- 6.1 Wired controller setting 25
- 6.2 Mobile device setting 28

7 INSTALLATION MANUAL

- 7.1 Safety precaution 35
- 7.2 Other precautions 38
- 7.3 Installation procedure and matching setting of
wired controller 39
- 7.4 Front cover installation 46

8 MODBUS MAPPING TABLE

- 8.1 Modbus port communication specification 48

1 GENERAL SAFETY PRECAUTIONS

1.1 About the documentation

- The original documentation is written in English. All other languages are translations.
- The precautions described in this document cover very important topics, follow them carefully.
- All activities described in the installation manual must be performed by an authorized installer.

1.1.1 Meaning of warnings and symbols

DANGER

Indicates a situation that results in death or serious injury.

DANGER: RISK OF ELECTROCUTION

Indicates a situation that could result in electrocution.

DANGER: RISK OF BURNING

Indicates a situation that could result in burning because of extreme hot or cold temperatures.

 **WARNING**

Indicates a situation that could result in death or serious injury.

 **CAUTION**

Indicates a situation that could result in minor or moderate injury.

 **NOTE**

Indicates a situation that could result in equipment or property damage.

 **INFORMATION**

Indicates useful tips or additional information.

1.2 For the user

- If you are not sure how to operate the unit, contact your installer.

- The appliance is not intended for use by persons, including children, with reduced physical, sensory or mental capabilities, or lack of experience and knowledge, unless they have been given supervision or instruction concerning use of the appliance by a person responsible for their safety. Children must be supervised to ensure that they do not play with the product.



CAUTION

Do NOT rinse the unit. This may cause electric shocks or fire.



NOTE

- Do NOT place any objects or equipment on top of the unit.
- Do NOT sit, climb or stand on the unit.

- Units are marked with the following symbol:



This means that electrical and electronic products may not be mixed with unsorted household waste. Do not try to dismantle the system yourself: the dismantling of the system, treatment of the refrigerant, of oil and of other parts must be done by an authorized installer and must comply with applicable legislation. Units must be treated at a specialized treatment facility for reuse, recycling and recovery. By ensuring this product is disposed of correctly, you will help to prevent potential negative consequences for the environment and human health. For more information, contact your installer or local authority.

2 A GLANCE OF THE USER INTERFACE

2.1 The appearance of the wired controller

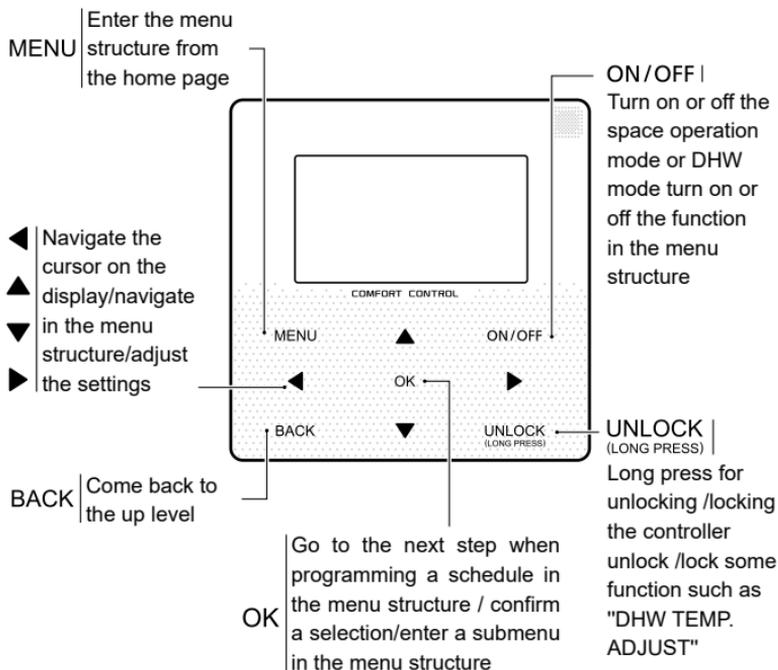

2.2 Status icons

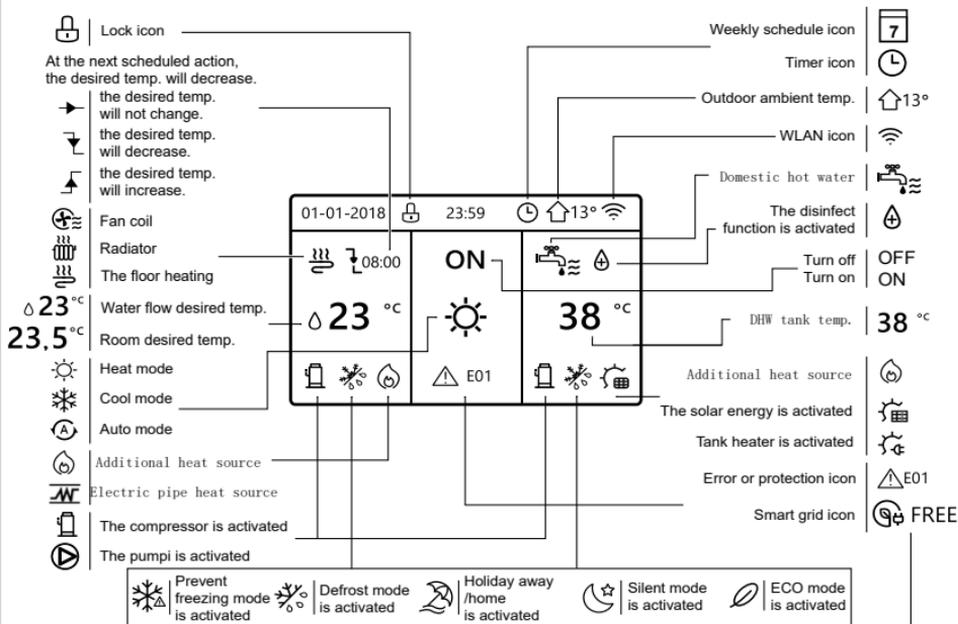

	Fan coil	Radiator	The floor heating	Domestic hot water
ON				
OFF				

	Free electricity	Valley electricity	Peak electricity
Smart grid	FREE	VALLEY	PEAK

3 USING HOME PAGES

3.1 About home pages

You can use the home pages to read out and change settings that are meant for daily usage. What you can see and do on the home pages is described where applicable. Depending on the system layout, the following home pages may be possible:

- Room desired temperature (ROOM)
- Water flow desired temperature (MAIN)
- DHW tank actual temperature (TANK)

DHW=domestic hot water

home page1 :

If you have set the WATER FLOW TEMP. as YES and ROOM TEMP. as NON, the system has the function including floor heating and making hot water. The following page will appear:

NOTE

All the pictures in the manual are used to explain, the actual pages in the screen may have some difference.

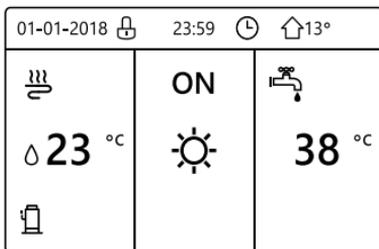

home page2 :

If you have set the WATER FLOW TEMP. as NON and ROOM TEMP. as YES, the system has the function including floor heating and making hot water. The following page will appear:

NOTE

The interface should be installed in the floor heating room to check the room temperature.

01-01-2018  23:59   13°		
 23.5 °C 	ON 	 38 °C

home page3 :

If the DHW MODE is set NON , and if "WATER FLOW TEMP." is set YES, "ROOM TEMP." is set YES, There will be main page and additional page. The system has the function including floor heating and space cooling for fan coil, home page 3 will appear:

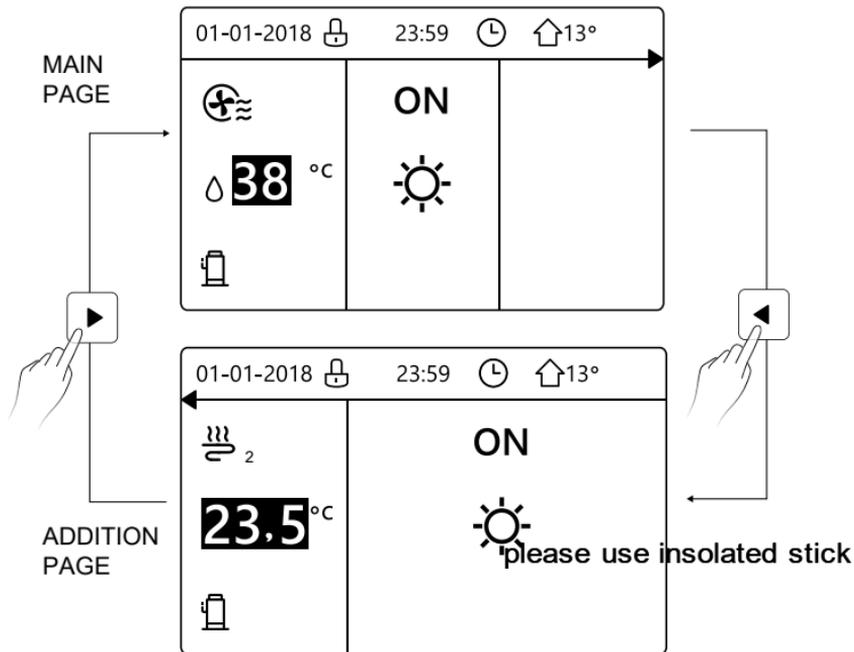

home page4 :

If the DHW MODE is set YES. There will be main page and addition page. The system has the function including floor heating, space cooling for fan coil and domestic hot water, home page 4 will appear:

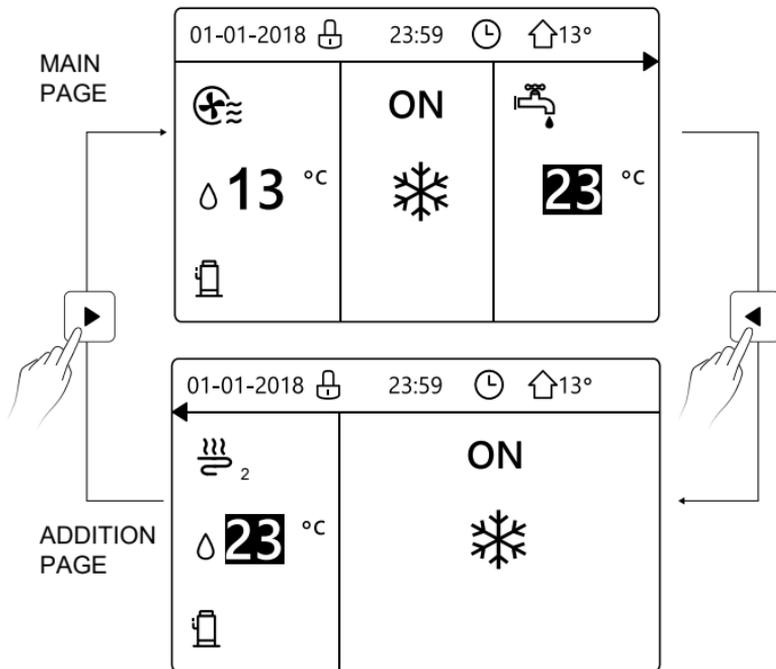

4 MENU STRUCTURE

4.1 About the menu structure

You can use the menu structure to read out and configure settings that are NOT meant for daily usage. What you can see and do in the menu structure is described where applicable.

4.2 To go to the menu structure

From a home page, press "MENU". Result: The menu structure appear:

MENU	1/2
OPERATION MODE	
PRESET TEMPERATURE	
DOMESTIC HOT WATER(DHW)	
SCHEDULE	
OPTIONS	
CHILD LOCK	
OK ENTER	

MENU	2/2
SERVICE INFORMATION	
OPERATION PARAMRTER	
FOR SERVICEMAN	
WLAN SETTING	
OK ENTER	

4.3 To navigate in the menu structure

Use"▼", "▲" to scroll.

5 BASIC USAGE

5.1 Screen Unlock

If the icon  is on the screen, the controller is locked. The following page is displayed:

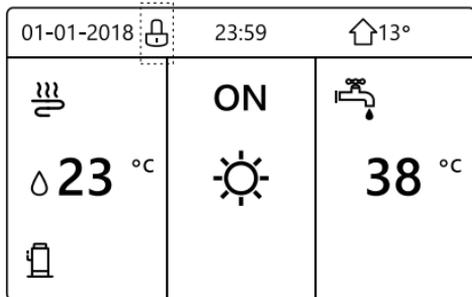

Press any key, the icon  will flash. Long press the "UNLOCK" key. The icon  will disappear, the interface can be controlled.

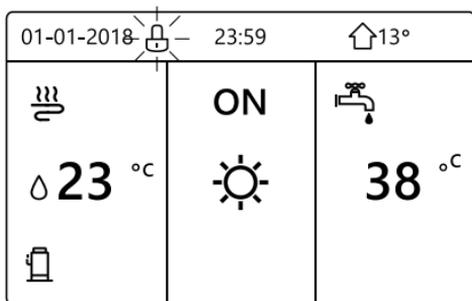

The interface will be locked if there is no handling for a long time (about 120 seconds). If the interface is unlocked, long press "unlock", the interface will be locked.

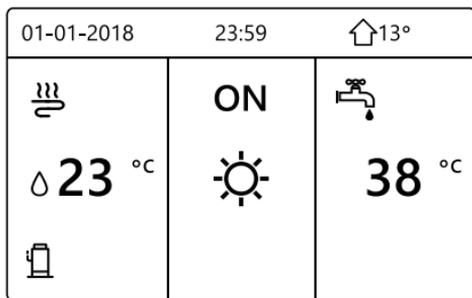

Long press
UNLOCK

UNLOCK

↓ ↑

UNLOCK

Long press
UNLOCK

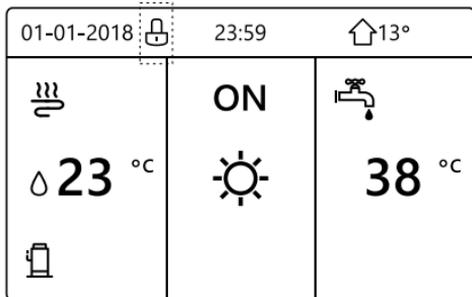

5.2 Turning ON/OFF controls

Use the interface to turn on or off the unit for space heating or cooling.

- The ON/OFF of the unit can be controlled by the interface if the ROOM THERMOSTAT is NON. (See "ROOM THERMOSTAT SETTING" in "Installation and owner's manual (M-thermal split indoor unit)")
- Press "◀", "▲" on home page, the black cursor will appear:

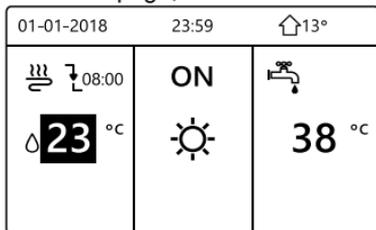

1) When the cursor is on the temperature of space operation mode side (Including heat mode , cool mode  and auto mode ) , press "ON/OFF" key to turn on/off space heating or cooling.

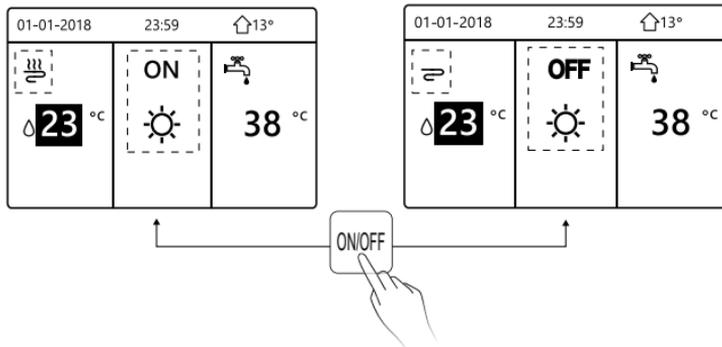

If the DHW TYPE is set NON, then following pages will display:

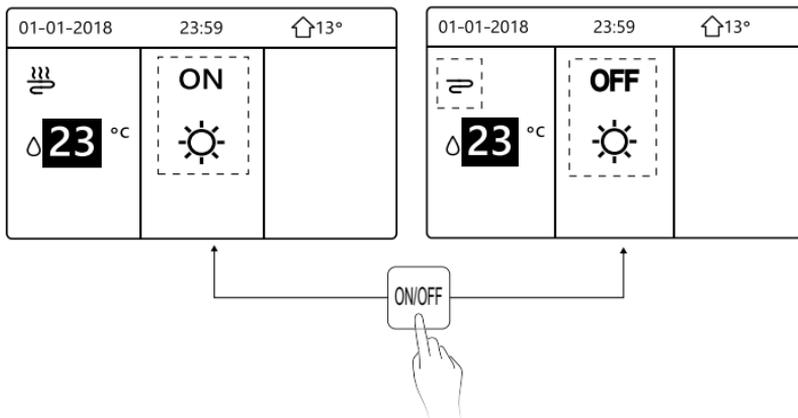

If the TEMP. TYPE is set ROOM TEMP., then following pages will display:

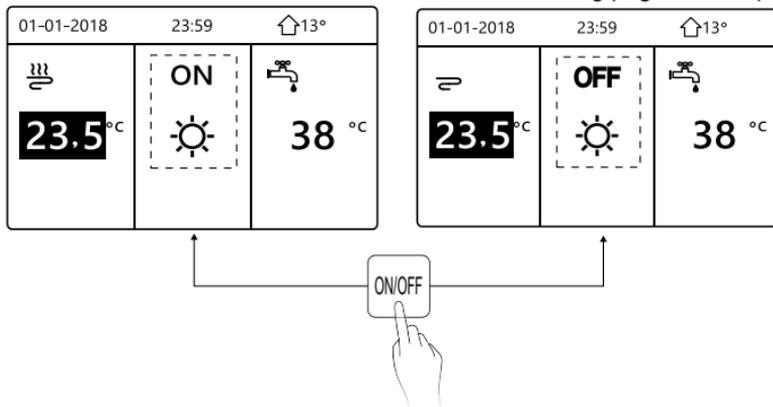

Use the room thermostat to turn on or off the unit for space heating or cooling.

① The room thermostat is SET YES(see "ROOM THERMOSTAT SETTING" on "Installation and owner's manual (M-thermal split indoor unit)") the unit is turned on or off by the room thermostat, press ON/OFF on the interface, the following page will display:

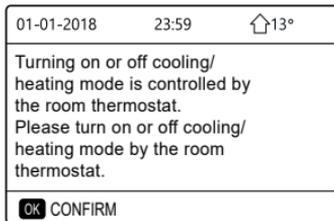

② DUAL ROOM THERMOSTAT is set YES(see "ROOM THERMOSTAT SETTING" in "Installation and owner's manual (M-thermal split indoor unit)").The room thermostat for fan coil is turned off ,the room thermostat for the floor heating is turned on,and the unit is running, but the display is OFF. The following page is displayed:

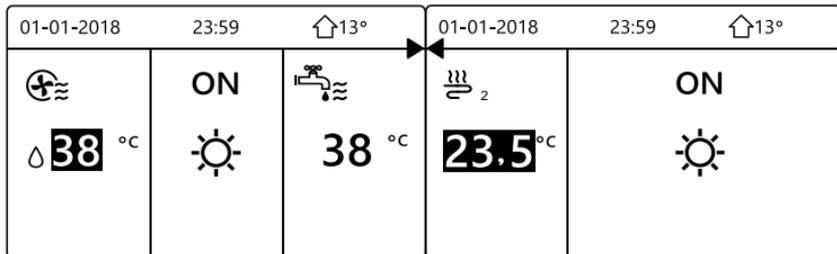

01-01-2018		23:59		🏠 13°		01-01-2018		23:59		🏠 13°	
⊕		OFF		🚰		↩ 2		OFF		☀	
Δ 38 °C		☀		38 °C		23.5 °C		☀			

Use the interface to turn on or off the unit for DHW. Press "▶", "▼" on home page, the black cursor will appear:

01-01-2018		23:59		🏠 13°	
☁		ON		🚰	
Δ 23 °C		☀		38 °C	

2) When the cursor is on DHW operation mode. Press "ON/OFF" key to turn on/off the DHW mode.

If the space operation is ON, then following pages will display:

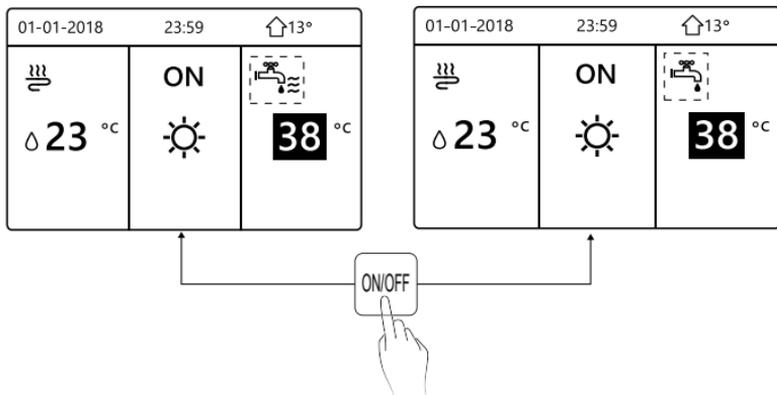

If the space operation mode is OFF, then following pages will display:

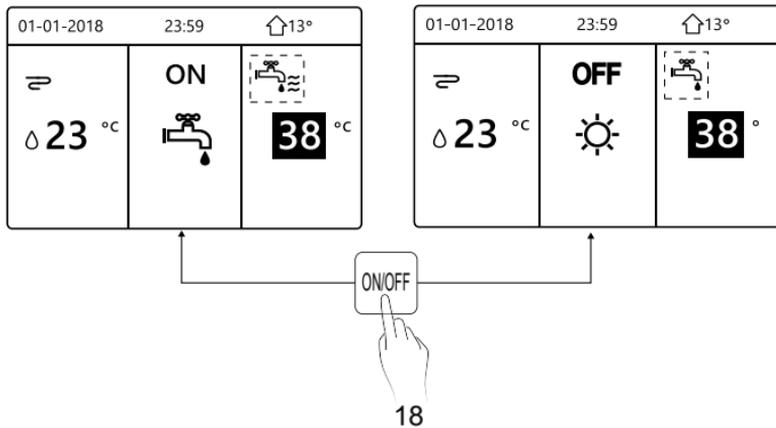

5.3 Adjusting the temperature

Press "◀", "▲" on home page, the black cursor will appear:

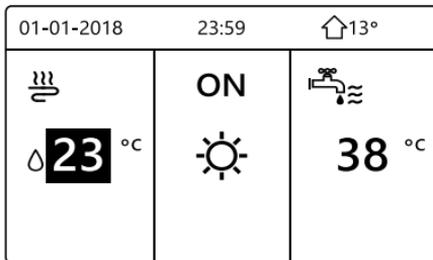

- If the cursor is on the temperature, use the "◀", "▶" to select and use "▼", "▲" to adjust the temperature.

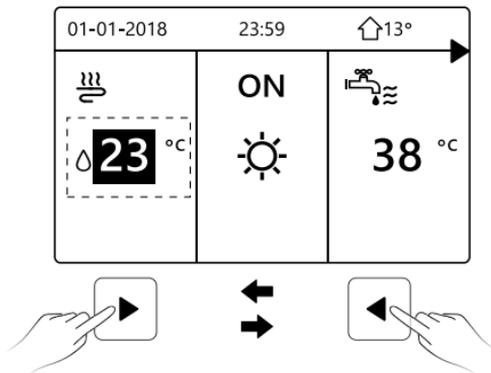

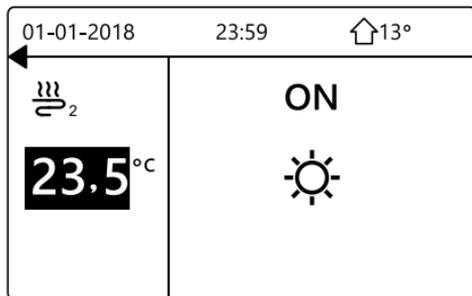
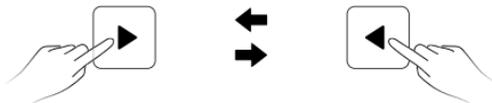
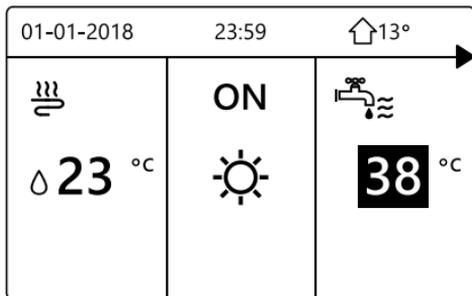

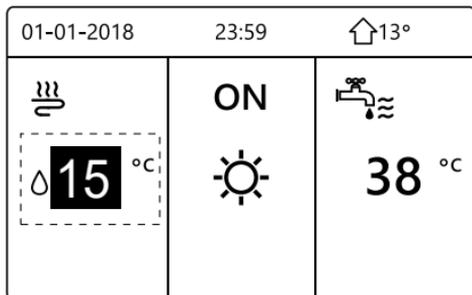
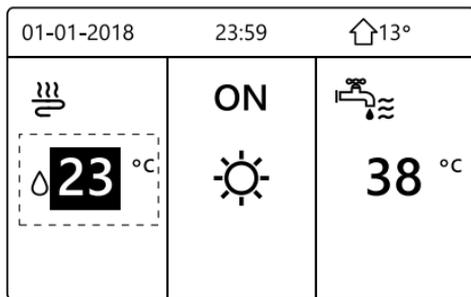

5.4 Adjusting space operation mode

- Adjusting space operation mode by interface. Go to "MENU" > "SPACE OPERATION MODE" . Press "OK", the following page will appear:

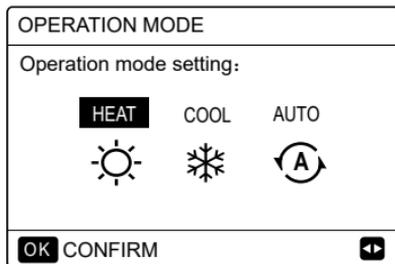

- There are three modes to be selected including HEAT, COOL and AUTO mode. Use the "◀", "▶" to scroll, press "OK" to select. Even if you don't press OK button and exit the page by pressing BACK button, the mode would still effective if the cursor have be moved to the operation mode.

If there is only HEAT(COOL) mode, the following page will appear:

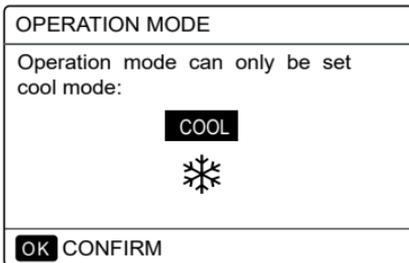
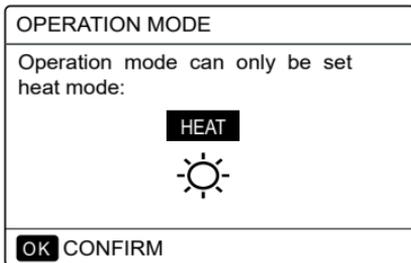

- The operation mode can not be changed see cool MODE SETTING on installation and ower's manual.

If you select...	Then the space operation mode is...
 heat	Always heating mode
 cool	Always cooling mode
 auto	<p>Automatically changed by the software based on the outdoor temperature (and depending on installer settings of the indoor temperature), and takes monthly restrictions into account.</p> <p>Note: Automatic changeover is only possible under certain conditions.</p> <p>See the FOR SERVICEMAN> AUTO MODE SETTING in "Installation and ower's manual (M-thermal split indoor unit)".</p>

- Adjust space operation mode by the room thermostat, see "ROOM THERMOSTAT" on "Installation and owner's manual (M-thermal split indoor unit)".

Go to MENU>OPERATION MODE, if you press any key to select or adjust, the follpage will appear:

01-01-2018	23:59	🏠13°
Cool/heat mode is controlled by the room thermostat.		
Please adjust the operation mode by the room thermostat.		
OK CONFIRM		

6 Network Configuration Guidelines

- The wired controller realizes intelligent control with a built-in module, which receives control signal from the APP.
- Before connecting the WLAN, please check for it if the router in your environment is active and make sure that the wired controller is well-connected to the wireless signal.
- During the Wireless distribution process, the LCD icon “” flashes to indicate that the network is being deployed. After the process is completed, the icon “” will be constantly on.

6.1 Wired Controller Setting

The wired controller settings include AP MODE and RESTORE WLAN SETTING.

WLAN SETTING
AP MODE
RESTORE WLAN SETTING
OK ENTER 

- Activate the WLAN by interface. Go to "MENU"> "WLAN SETTING"> "AP MODE".

Press"OK", the following page will appear:

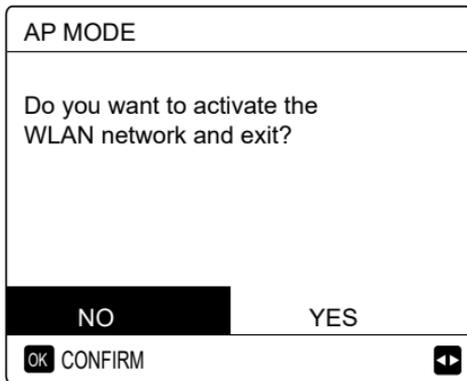

Use "◀", "▶" to move to"YES", press "OK" to select AP mode. Select AP Mode correspondingly on the mobile device and continue the follow-up settings according to the APP prompts.

CAUTION

After enter Ap mode, if it's not connected with mobile phone, the LCD icon "📶" will flash 10 minutes then disappear.

If it's connected with the mobile phone, the icon "📶" will be constantly display.

- Restore WLAN setting by interface. Go to "MENU"> "WLAN SETTING" > "RESTORE WLAN SETTING" .

Press "OK", the following page will appear:

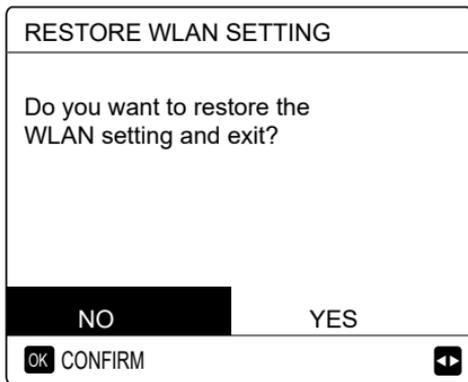

Use "◀", "▶" to move to "YES", press "OK" to restore WLAN setting. Complete the above operation and wireless configuration is reset.

6.2 Mobile Device Setting

AP Mode is available for wireless distribution on mobile device side.

- AP Mode connecting WLAN:

6.2.1 Install APP

- ① Scan the following QR code to install the Smart Home APP.



- ② Please research "Comfort Home" in APP STORE or GOOGLE PLAY to install the APP.

This APP is only applicable to Android 7.0 and IOS7, or newer operation systems.

6.2.2 Sign in/Sign up

Please input your registration code.

Or scan the QR code on the controller packaging box if existed.

And register your account according to the guidance.

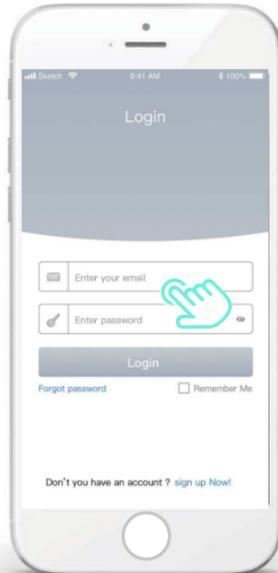
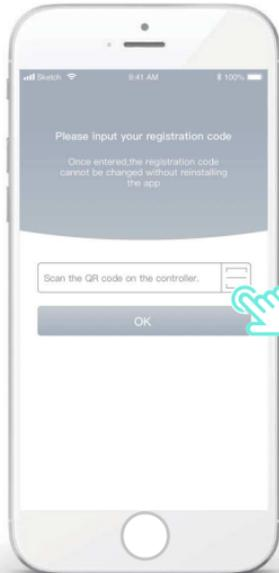

6.2.3 Add Home Appliances:

- 1) Add your device following the guidance.

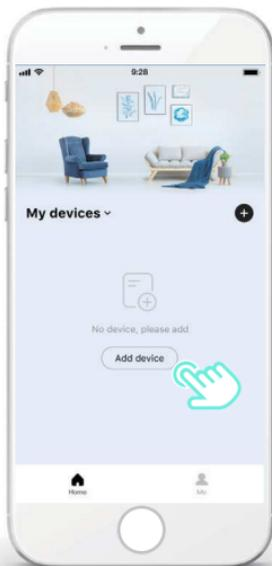

2) Operate the wired controller according to APP prompts.



3) Wait for the home appliance to connect, and click “Sure”.

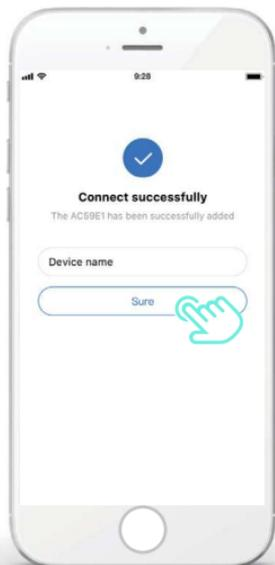

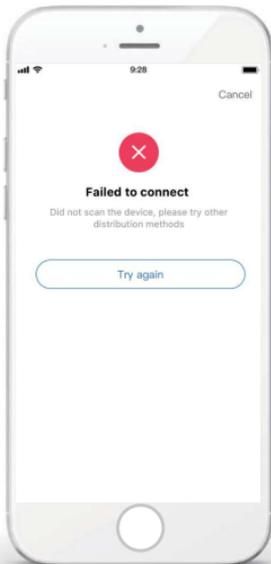
- 4) After the appliance is successfully connected, the LCD icon“



Warning and troubleshooting for networking failures

When the product is connected to the network, please make sure that the phone is as close as possible to the product.

We only support 2.4GHz band routers at present.

Special characters (punctuation, spaces, etc.) are not recommended as part of the WLAN name.

It is recommended that you connect no more than 10 devices to a single router lest home appliances are affected by weak or unstable network signal.

If the password of the router or WLAN is changed, clear all settings and reset the appliance.

The contents of APP might change in version updates and actual operation shall prevail.

7 INSTALLATION MANUAL

7.1 Safety precaution

- Read the safety precautions carefully before installing the unit.
- Stated below are important safety issues that must be obeyed.
- Conform there is no abnormal phenomena during test operation after complete, then hand the manual to the user.
- Meaning of marks:



WARNING

Means improper handling may lead to personal death or severe injury.



CAUTION

Means improper handling may lead to personal injury or property loss.

 **WARNING**

Please entrust the distributor or professionals to install the unit. Installation by other persons may lead to imperfect installation, electric shock or fire.

Strictly follow this manual.
Improper installation may lead to electric shock or fire.

Reinstallation must be performed by professionals.
improper installation may lead to electric shock or fire.

Do not disassemble your air conditioner at will.
A random disassembly may cause abnormal operation or heating, which may result in fire.

CAUTION

Do not install the unit in a place vulnerable to leakage of flammable gases.

Once flammable gases are leaked and left around the wired controller, fire may occur.

The wiring should adapt to the wired controller current.

Otherwise, electric leakage or heating may occur and result in fire.

The specified cables shall be applied in the wiring. No external force may be applied to the terminal.

Otherwise, wire cut and heating may occur and result in fire.

Do not place the wired remote controller near the lamps, to avoid the remote signal of the controller to be disturbed. (refer to the right figure)



7.2 Other Precautions

7.2.1. Installation location

Do not install the unit in a place with much oil, steam, sulfide gas. Otherwise, the product may deform and fail.

7.2.2 Preparation before installation

1) Check whether the following assemblies are complete.

No.	Name	Qty.	Remarks
1	Wired Controller	1	_____
2	Cross round head wood mounting screw	3	For Mounting on the Wall
3	Cross round head mounting screw	2	For Mounting on the Electrical Switch Box
4	Installation and Owner's Manual	1	_____
5	Plastic bolt	2	This accessory is used when install the centralized control inside the electric cabinet
6	Plastic expansion pipe	3	For mounting on the Wall

7.2.3 Note for installation of wired controller:

- 1) This installation manual contains information about the procedure of installing Wired Remote Controller. Please refer to Indoor Unit Installation Manual for connection between Wired Remote Controller and Indoor Unit.
- 2) Circuit of Wired Remote Controller is low voltage circuit. Never connect it with a standard 220V/380V circuit or put it into a same Wiring Tube with the circuit.
- 3) The shielded cable must be connected stable to the ground, or transmission may fail.
- 4) Do not attempt to extend the shielded cable by cutting, if it is necessary, use Terminal Connection Block to connect.
- 5) After finishing connection, do not use Megger to have the insulation check for the signal wire.

7.3 Installation procedure and matching setting of wired controller

7.3.1 Structure size figure

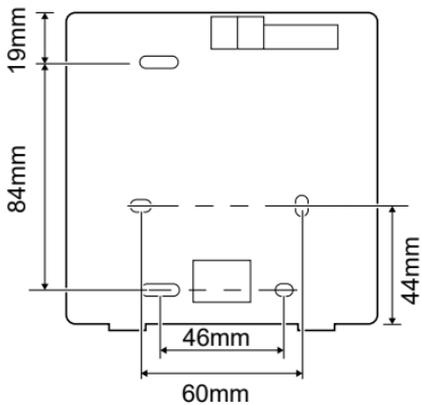
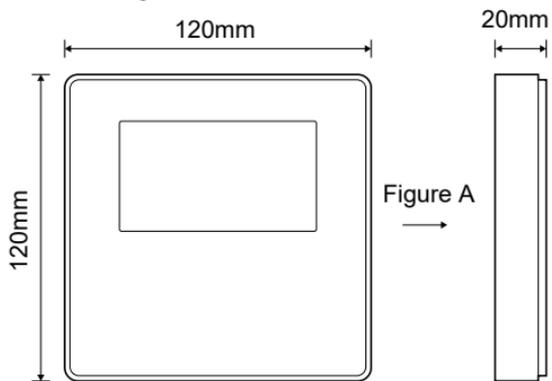

7.3.2 Wiring

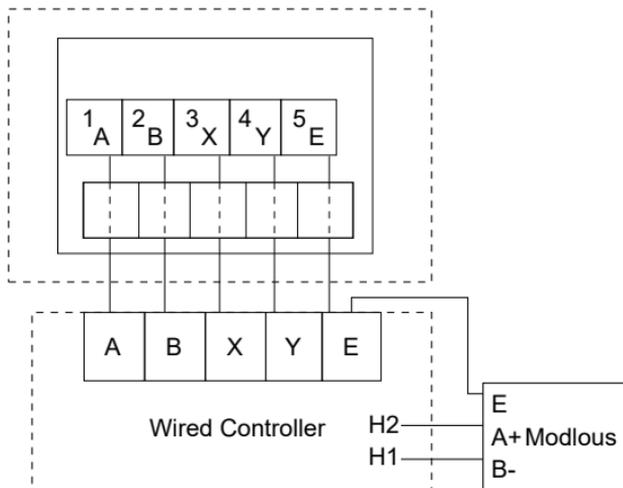

Input Voltage(A/B)	13.5VAC
Wiring size	0.75mm ²

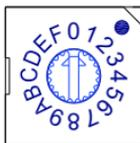

The rotating coded switch S3(0-F) on the main control board of hydraulic module is used for set the modbus address.

By default the units have this coded switch positioned=0, but this corresponds to the modbus address 16, while the others positions corresponds the number, e.g. pos=2 is address 2, pos=5 is address 5.

7.3.3 Back cover installation

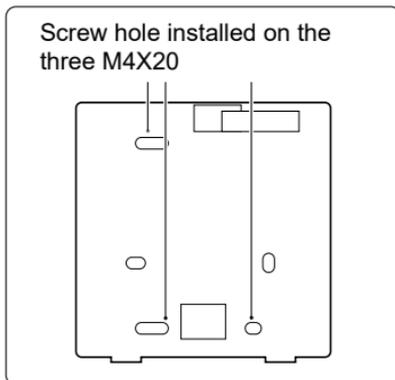
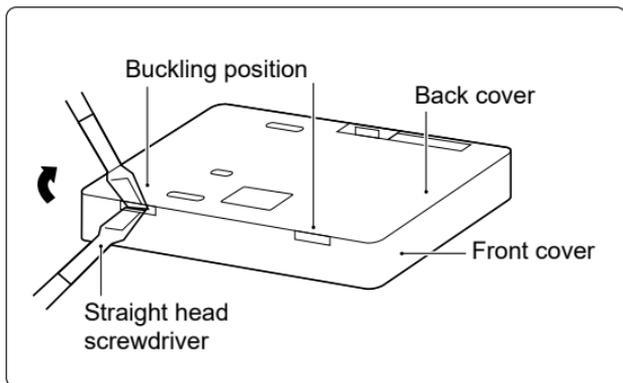

Screw hole installed on the
three M4X20

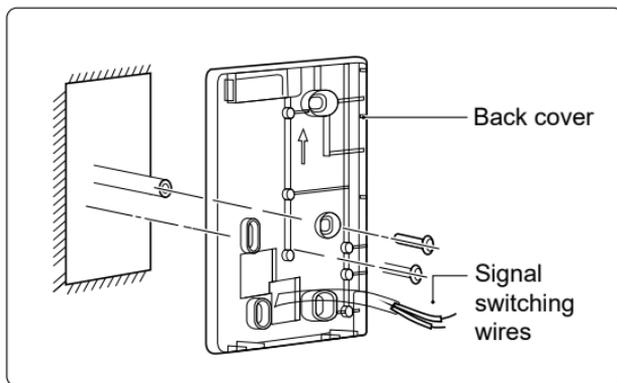
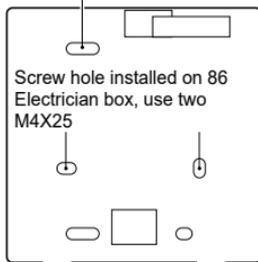

- 1) Use straight head screwdriver to insert in the buckling position in the bottom of wired controller, and spin the screwdriver to take down the back cover. (Pay attention to spinning direction, otherwise will damage the back cover!)
- 2) Use three M4X20 screws to directly install the back cover on the wall.
- 3) Use two M4X25 screws to install the back cover on the 86 electrician box, and use one M4X20 screws for fixing on the wall.
- 4) Adjust the length of two plastic screw bars in the accessory to be standard length from the electrical box screw bar to the wall. Make sure while installing the screw bar to the wall, making it as flat as the wall.
- 5) Use cross head screws to fix the wired controller bottom cover in the wall through the screw bar. Make sure the wired controller bottom cover is on the same level after installation, and then install the wired controller back to the bottom cover.
- 6) Over fastening the screw will lead to deformation of back cover.

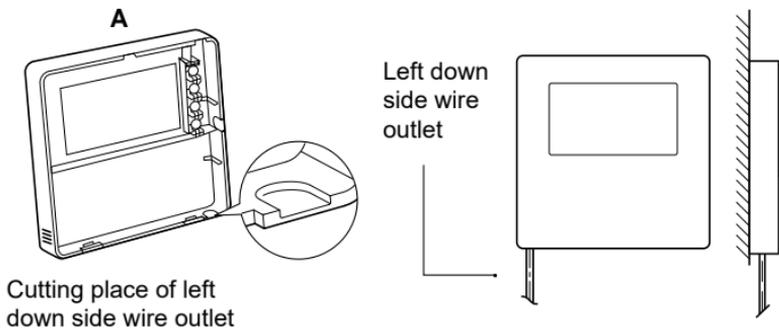

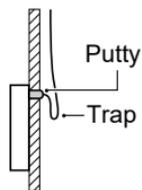
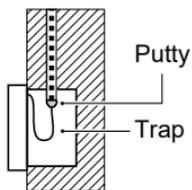
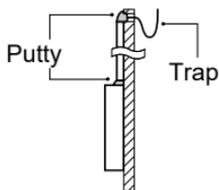
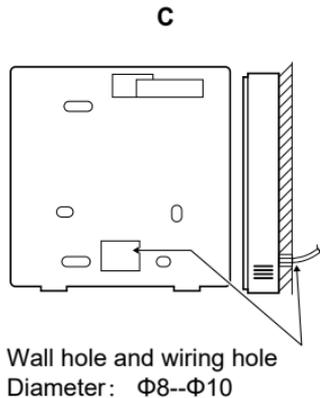
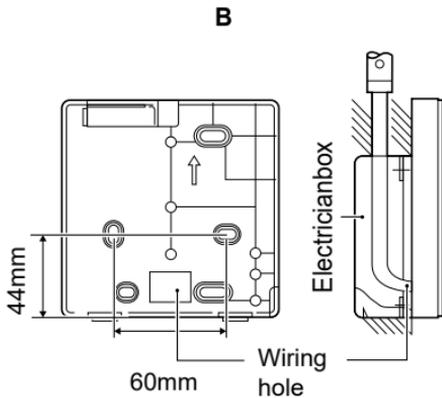

Avoid the water enter into the wired remote controller, use trap and putty to seal the connectors of wires during wiring installation.

7.4 Front cover installation

After adjusting the front cover and then buckle the front cover; avoid clamping the communication switching wire during installation.

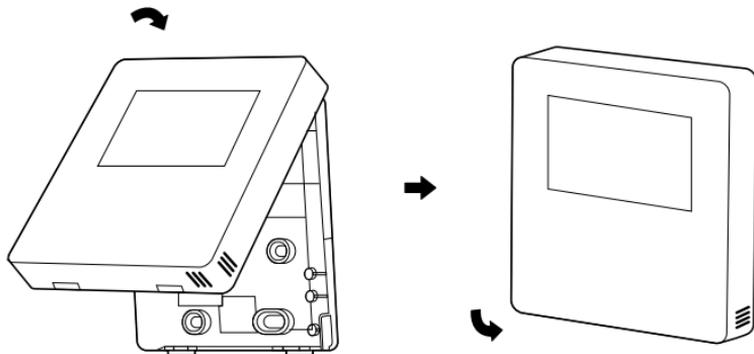

Sensor can not be affected with damp.

Correct install the back cover and firmly buckle the front cover and back cover, otherwise will make the front cover drop off.



8 MODBUS MAPPING TABLE

8.1 Modbus Port Communication Specification

Port: RS-485; the wired controller XYE is the communication port for connecting with the hydraulic module. H1 and H2 are the Modbus communication ports.

Communication address: It is consistent with the DIP switch address of the hydraulic module.

Baud rate: 9600.

Number of digits: Eight

Verification: none

Stop Bit: 1 bit

Communication protocol: Modbus RTU (Modbus ASCII is not supported)

8.1.1 Mapping of registers in the wired controller

The following addresses can use 03H, 06H (write single register), 10H (write multiple register)

Register address	Description	Remarks	
0 (PLC:40001)	Power on or off.	BIT15	Reserved
		BIT14	Reserved
		BIT13	Reserved
		BIT12	Reserved
		BIT11	Reserved
		BIT10	Reserved
		BIT9	Reserved
		BIT8	Reserved
		BIT7	Reserved
		BIT6	Reserved
		BIT5	Reserved
		BIT4	Reserved
		BIT3	0:power off air conditioner; 1: power on air conditioner(zone 2)
		BIT2	0: DHW(T5S) power off; 1: DHW(T5S) power on
		BIT1	0:power off air conditioner; 1: power on air conditioner(zone 1)
BIT0	0: power off floor heating; 1: power on floor heating		

1 (PLC:40002)	Setting the mode	1: Auto; 2: Cool; 3: Heat; Others: Invalid	
2 (PLC:40003)	Setting water temperature T1s	Water temperature T1s is corresponding to the floor heating.	
3 (PLC:40004)	Setting air temperature Ts	The room temperature range is between 17°C and 30°C, and is valid when there is Ta.	
4 (PLC:40005)	T5s	The water tank temperature range is between 40°C and 60°C.	
5 (PLC:40006)	Function setting	BIT15	Reserved
		BIT14	Reserved
		BIT13	Reserved
		BIT12	1: curve setting is enabled; 0: curve setting is disabled.
		BIT11	DHW pump's running constant-temperature water recycling
		BIT10	ECO mode
		BIT9	Reserved
		BIT8	Holiday home (the status can only be read, not changed)
		BIT7	0: Silent mode level1; 1: Silent mode level2
		BIT6:	Silent mode
		BIT5:	Holiday away (the status can only be read, but cannot be changed)
		BIT4:	Disinfect
	BIT3:	Reserved	
	BIT2:	Reserved	
	BIT1:	Reserved	
	BIT0:	Reserved	
6 (PLC:40007)	Curve selection	Curve 1-8	
7 (PLC:40008)	Forced water heating	0: Invald 1: Forced on 2: Forced off	TBH is the electric water tank heater. IBH1 and 2 are the hydraulic module's rear electric heater. IBH1 and 2 can be activated together. TBH cannot be activated together with IBH1 and 2.
8 (PLC:40009)	Forced TBH		
9 (PLC:40010)	Forced IBH1		
10 (PLC:40011)	t_SG_MAX	0-24 Hours	

In cooling mode, T1S low temp setting range is 5~25°C; T1S high temp setting range is 18~25°C.

In heating mode, T1S low temp setting range is 22~55°C; T1S high temp setting range is 35~60°C.

8.1.2 When the wired controller is connected to the hydraulic module, the parameters of the whole unit can be checked:

Whole unit parameter mapping address table

1) Running parameters

Register address	Description	Remarks
100 (PLC:40101)	Operating frequency	Compressor operating frequency in Hz
101 (PLC:40102)	Operating Mode	Whole unit's actual operating mode, 2: cooling, 3: heating, 0: off
102 (PLC:40103)	Fan Speed	Fan speed, in r/min
103 (PLC:40104)	PMV openness	Openness of the outdoor unit's electronic expansion valve in P (only multiples of 8 are shown)
104 (PLC:40105)	Water inlet temperature	TW_in, in °C
105 (PLC:40106)	Water outlet temperature	TW_out, in °C
106 (PLC:40107)	T3 Temperature	Condenser temperature, in °C
107 (PLC:40108)	T4 Temperature	Outdoor ambient temperature in °C
108 (PLC:40109)	Discharge temperature	Compressor discharge temperature Tp in °C
109 (PLC:40110)	Return air temperature	Compressor air return temperature in °C
110 (PLC:40111)	T1	Total water outlet temperature in °C
111 (PLC:40112)	T1B	System total water outlet temperature (behind the auxiliary heater) °C
112 (PLC:40113)	T2	Refrigerant liquid side temperature in °C
113 (PLC:40114)	T2B	Refrigerant gas side temperature in °C
114 (PLC:40115)	Ta	Room temperature, in °C
115 (PLC:40116)	T5	Water tank temperature
116 (PLC:40117)	Pressure 1	Outdoor unit high pressure value, in kPa
117 (PLC:40118)	Pressure 2	Outdoor unit low pressure value, in kPa
118 (PLC:40119)	Outdoor unit current	Outdoor unit operating current, in A
119 (PLC:40120)	Outdoor unit voltage	Outdoor unit voltage in V
120 (PLC:40121)	Hydraulic module current 1	Hydraulic module current 1 in A (reserved)
121 (PLC:40122)	Hydraulic module current 2	Hydraulic module current 2 in A (reserved)
122 (PLC:40123)	Compressor operating time	Compressor operating time in hour
123 (PLC:40124)	Reserved	Reserved
124 (PLC:40125)	Current fault	Check the code table for detailed fault codes
125 (PLC:40126)	Fault 1	Check the code table for detailed fault codes.
126 (PLC:40127)	Fault 2	
127 (PLC:40128)	Fault 3	

128 (PLC:40129)	Status bit 1	BIT15	Reserved
		BIT14	Reserved
		BIT13	Reserved
		BIT12	Reserved
		BIT11	EUV 1:free electricity; 0:judge by SG's signal
		BIT10	SG 1:normal electricity; 0:high price electricity (judge when EUV is 0)
		BIT9	Reserved
		BIT8	Solar energy signal input
		BIT7	Room temperature controller cooling
		BIT6:	Room temperature controller heating
		BIT5:	Outdoor unit test mode mark
		BIT4:	Remote On/Off (1: d8)
		BIT3:	Oil return
		BIT2:	Anti-freezing
BIT1:	Defrosting		
BIT0:	Reserved		
129 (PLC:40130)	Load output	BIT15	DEFROST
		BIT14	External heater
		BIT13	RUN
		BIT12	ALARM
		BIT11	Solar water pump
		BIT10	HEAT4
		BIT9	SV2
		BIT8	Mixed water pump P_c
		BIT7	Water return water P_d
		BIT6:	External water pump P_o
		BIT5:	Reserved
		BIT4:	SV1
		BIT3:	Water pump PUMP_I
		BIT2:	Electric heater TBH
BIT1:	Reserved		
BIT0:	Electric heater IBH1		
130 (PLC:40131)	Whole unit version No.	1-99 is the whole unit's version number and refers to the hydraulic module's version number.	
131 (PLC:40132)	Wired controller version No.	1-99 is the wired controller's version number.	

132 (PLC:40133)	Unit target frequency	
133 (PLC:40134)	Dc bus current	In A
134 (PLC:40135)	Dc bus voltage	The actual value/10, in V
135 (PLC:40136)	TF module temperature	Feedback on outdoor unit,in °C
136 (PLC:40137)	Hydraulic module curve T1S calculated value 1	The corresponding calculated value of zone 1
137 (PLC:40138)	Hydraulic module curve T1S calculated value 2	The corresponding calculated value of zone 2
138 (PLC:40139)	Water flow	The actual value*100, in m ³ /H
139 (PLC:40140)	Limit scheme of outdoor unit current	Scheme value
140 (PLC:40141)	Ability of Hydraulic module	The actual value*100, in kW

2) Parameter setting

Register address	Description	Remarks	
200 (PLC:40201)	Home appliance type	The upper 8 bit is the home appliance type: Central heating: 0x07	
201 (PLC: 40202)	Temperature upper limit of T1S cooling		
202 (PLC: 40203)	Temperature lower limit of T1S cooling		
203 (PLC: 40204)	Temperature upper limit of T1S heating		
204 (PLC: 40205)	Temperature lower limit of T1S heating		
205 (PLC: 40206)	Temperature upper limit of TS setting		
206 (PLC: 40207)	Temperature lower limit of TS setting		
207 (PLC: 40208)	Temperature upper limit of water heating		
208 (PLC: 40209)	Temperature lower limit of water heating		
209 (PLC: 40210)	PUMP RUNNING TIME	DHW PUMP water return running time. It is five minutes by default and can be adjusted between 5 and 120 min at an interval of 1 min.	
210 (PLC: 40211)	Parameter setting 1	BIT15	Enable water heating
		BIT14	Supports water tank electric heater TBH(Read-only)
		BIT13	Supports disinfection
		BIT12	DHW PUMP, 1: supported; 0: not supported
		BIT11	Reserved
		BIT10	DHW pump supports Pipe Disinfect
		BIT9	Enable cooling
		BIT8	T1S cooling high/low temperature settings(Read-only)
		BIT7	Enable heating
		BIT6:	T1S heating high/low temperature settings(Read-only)
		BIT5:	Supports T1 sensor
		BIT4:	Supports room temperature Sensor Ta
		BIT3:	Supports room thermostat
		BIT2:	Room thermostat
BIT1:	Dual Room Thermostat, 0: not supported; 1: supported		
BIT0:	0: room cooling/heating first, 1: water heating first		

211 (PLC:40212)	Parameter setting 2	BIT15	Reserved
		BIT14	Reserved
		BIT13	Reserved
		BIT12	Reserved
		BIT11	Reserved
		BIT10	Reserved
		BIT9	Reserved
		BIT8	Define the port, 0=remote ON/OFF; 1=DHW heater
		BIT7	Smart grid, 0=NON; 1=YES
		BIT6:	Enable or disable the Tw2, 0=NON ; 1=YES
		BIT5:	Setting the high/low temperature of cooling mode T1S
		BIT4:	Setting the high/low temperature of heating mode T1S
		BIT3:	Double zone setting is valid
		BIT2:	Reserved
BIT1:	Reserved		
BIT0:	Reserved		
212 (PLC: 40213)	dT5_On	Default setting: 5°C, range: 2~10°C, setting interval: 1°C	
213 (PLC: 40214)	dT1S5	Default setting: 10°C, range: 5~40°C, setting interval: 1°C	
214 (PLC: 40215)	T_Interval_DHW	Default setting: 5 min, range: 5~30 min, setting interval: 1 min	
215 (PLC: 40216)	T4DHWmax	Default setting: 43°C, range: 35~43°C, setting interval: 1°C	
216 (PLC: 40217)	T4DHWmin	Default setting: -10°C, range: -25~5°C, setting interval: 1°C	
217 (PLC: 40218)	t_TBH_delay	Default setting: 30 min, range: 0~240 min, setting interval: 5 min	
218 (PLC: 40219)	dT5_TBH_off	Default setting: 5°C, range: 0~10°C, setting interval: 1°C	
219 (PLC: 40220)	T4_TBH_on	Default setting: 5°C, range: -5~20°C, setting interval: 1°C	
220 (PLC: 40221)	T5s_DI	Temperature of the disinfection water tank, range: 60~70°C, default setting: 65°C	

221 (PLC: 40222)	t_DI_max	Maximum disinfection duration, range: 90~300 min, default setting: 210 min
222 (PLC: 40223)	t_DI_hightemp	Disinfection high temperature duration, range: 5~60 min, default setting: 15 min
223 (PLC: 40224)	t_interval_C	Time interval of compressor start-up in cooling mode; range: 5~30 min, default setting: 5 min
224 (PLC: 40225)	dT1SC	Default setting: 5°C, range: 2~10°C, setting interval: 1°C
225 (PLC: 40226)	dTSC	Default setting: 2°C, range: 1~10°C, setting interval: 1°C
226 (PLC: 40227)	T4cmax	Default setting: 43°C, range: 35~46°C, setting interval: 1°C
227 (PLC: 40228)	T4cmin	Default setting: 10°C, range: -5~25°C, setting interval: 1°C
228 (PLC: 40229)	t_interval_H	Time interval of compressor start-up in the heating mode; range: 5~60 min, default setting: 5 min
229 (PLC: 40230)	dT1SH	Default setting: 5°C, range: 2~10°C, setting interval: 1°C
230 (PLC: 40231)	dTSH	Default setting: 2°C, range: 1~10°C, setting interval: 1°C
231 (PLC: 40232)	T4hmax	Default setting: 25°C, range: 20~35°C, setting interval: 1°C
232 (PLC: 40233)	T4hmin	Default setting: -15°C, range: -25~5°C, setting interval: 1°C
233 (PLC: 40234)	T4_IBH_on	Ambient temperature for enabling the hydraulic module auxiliary electric heating IBH, range: -15~10°C; default setting: -5°C
234 (PLC: 40235)	dT1_IBH_on	Temperature return difference for enabling the hydraulic module auxiliary electric heating IBH, range: 2~10°C; default setting: 5°C
235 (PLC: 40236)	t_IBH_delay	Delay time of enabling the hydraulic module auxiliary electric heating IBH, range: 15~120 min; default setting: 30 min

237 (PLC: 40238)	T4_AHS_on	Ambient temperature for enabling the external heater AHS, range: -15~10°C, setting interval: -5°C
238 (PLC: 40239)	dT1_AHS_on	Temperature return difference for enabling the external heater AHS, range: 2~10°C; default setting: 5°C

240 (PLC: 40241)	t_AHS_delay	Delay time for enabling the external heater AHS, range: 5~120 min; default setting: 30 min
------------------	-------------	--

241 (PLC: 40242)	t_DHWHP_max	Longest duration of water heating by the heat pump, range: 10~600 min, default setting: 120 min;
242 (PLC: 40243)	t_DHWHP_restrict	Duration of limited water heating by the heat pump, range: 10~600 min, default setting: 30 min;
243 (PLC: 40244)	T4autocmin	Default setting: 25°C, range: 20~29°C, setting interval: 1°C
244 (PLC: 40245)	T4autohmax	Default setting: 17°C, range: 10~17°C, setting interval: 1°C
245 (PLC: 40246)	T1S_H.A.H	In the holiday mode, setting of T1 in the heating mode, range: 20~25°C, default setting: 25°C
246 (PLC: 40247)	T5S_H.A.DHW	In the holiday mode, setting of T1 in the water heating mode, range: 20~25°C, default setting: 25°C
247 (PLC: 40248)	ECO parameter	Reserved, wrong address is reported when this register is queried
248 (PLC: 40249)	ECO parameter	Reserved, wrong address is reported when this register is queried
249 (PLC: 40250)	ECO parameter	Reserved, wrong address is reported when this register is queried
250 (P LC:40251)	ECO parameter	Reserved, wrong address is reported when this register is queried
251 (PLC: 40252)	Comfort parameter	Reserved, wrong address is reported when this register is queried
252 (P LC:40253)	Comfort parameter	Reserved, wrong address is reported when this register is queried
253 (PLC: 40254)	Comfort parameter	Reserved, wrong address is reported when this register is queried
254 (P LC:40255)	Comfort parameter	Reserved, wrong address is reported when this register is queried
255 (PLC: 40256)	t_DRYUP	Temperature rise day number, range: 4~15 days, default setting: 8 days
256 (PLC: 40257)	t_HIGHPEAK	Drying day number, range: 3~7 days, default setting: 5 days
257 (PLC: 40258)	t_DRYD	Temperature drop day number, range: 4~15 days, default setting: 5 days
258 (PLC: 40259)	T_DRYPEAK	Highest drying temperature, range: 30~55°C, default setting: 45°C
259 (PLC: 40260)	t_firstFH	Running time of floor heating for the first time, default setting: 72 hrs, range: 48-96 hrs
260 (PLC: 40261)	T1S (first floor heating)	T1S of floor heating for the first time, range: 25~35°C, default setting: 25°C

261 (PLC: 40262)	T1SetC1	Parameter of the ninth temperature curves for cooling mode, range:5~25 °C, default setting: 10 °C;
262 (PLC: 40263)	T1SetC2	Parameter of the ninth temperature curves for cooling mode, range:5~25 °C, default setting: 16 °C;
263 (PLC: 40264)	T4C1	Parameter of the ninth temperature curves for cooling mode, range:(-5)~46 °C, default setting: 35 °C;
264 (PLC: 40265)	T4C2	Parameter of the ninth temperature curves for cooling mode, range:(-5)~46 °C, default setting: 25 °C;
265 (PLC: 40266)	T1SetH1	Parameter of the ninth temperature curves for cooling mode, range:25~60 °C, default setting: 35 °C;
266 (PLC: 40267)	T1SetH2	Parameter of the ninth temperature curves for cooling mode, range:25~60 °C, default setting: 28 °C;
267 (PLC: 40268)	T4H1	Parameter of the ninth temperature curves for cooling mode, range:(-25)~30 °C, default setting: -5 °C;
268 (PLC: 40269)	T4H2	Parameter of the ninth temperature curves for cooling mode, range:(-25)~30 °C, default setting: 7 °C;
269 (PLC: 40270)		The type of power input limitation, 0=NON, 1~8=type 1~8, default:0
270 (PLC: 40271)	HB:t_T4_FRESH_C	range:0.5~6 hour, setting interval:0.5 hour, sending value=actual value*2
	LB:t_T4_FRESH_H	range:0.5~6 hour, setting interval:0.5 hour, sending value=actual value*2
271 (PLC: 40272)	T_PUMPI_DELAY	range:2~20 hour, setting interval:0.5 hour, sending value=actual value*2:
272 (PLC: 40273)	EMISSION TYPE	Bit12-15: The type of zone 2 end for cooling mode
		Bit8-11: The type of zone 1 end for cooling mode
		Bit4-7: The type of zone 2 end for heating mode
		Bit0-3: The type of zone 1 end for heating mode



NOTE

A series of 18 horizontal dotted lines for writing notes.

- Dieses Handbuch bietet Ihnen eine detaillierte Beschreibung der Vorsichtsmaßnahmen, die Sie in Betracht nehmen müssen während des Betriebs.
- Um das richtige Service für die kabelgebundene Fernbedienung zu sichern, lesen Sie dieses Handbuch genau durch, bevor Sie die Einheit nutzen.
- Um die zukünftige Nutzung zu erleichtern, behalten Sie das Handbuch nach dem Lesen.

INHALT

1 ALLGEMEINE SICHERHEITSVORKEHRUNGEN

- 1.1 Über die Dokumentation 1
- 1.2 Für den Nutzer 2

2 EIN BLICK AUF DIE BEDIENOBERFLÄCHE

- 2.1 Aussehen der kabelgebundenen Fernbedienung 5
- 2.2 Status-Icons 6

3 NUTZUNG DER HOME-SEITEN

- 3.1 Über Startseiten 7

4 MENÜSTRUKTUR

- 4.1 Über die Menüstruktur..... 11
- 4.2 Menüstruktur aufrufen..... 11
- 4.3 In der Menüstruktur navigieren..... 11

5 GRUNDBEDIENUNG

- 5.1 Bildschirm Entsper..... 12
- 5.2 Steuerung AN/AUS..... 14
- 5.3 Temperatur anpas..... 19
- 5.4 Raumbetriebsmodus anpas..... 22

6 Netzwerk-Konfigurationsanweisungen

- 6.1 Einstellungen des kabelgebundenen Controllers 25
- 6.2 Einstellung des mobilen Gerätes..... 28

7 INSTALLATIONSANLEITUNG

- 7.1 Sicherheitsvorkehrungen..... 35
- 7.2 Andere Vorsichtsmaßnahmen..... 38
- 7.3 Installationsverfahren und Anpassung der
Einstellung der kabelgebundenen Steuerung 39
- 7.4 Montage der Frontabdeckung..... 46

1 ALLGEMEINE SICHERHEITSVORKEHRUNGEN

1.1 Über die Dokumentation

- Die Originaldokumentation ist in englischer Sprache verfasst. Alle anderen Sprachen sind Übersetzungen.
- Die Vorsichtsmaßnahmen, die in diesem Dokument aufgeführt sind beinhalten sehr wichtige Themen, befolgen Sie genau.
- Alle in der Installationsanleitung beschriebenen Tätigkeiten müssen von einem autorisierten Installateur durchgeführt werden.

1.1.1 Bedeutung der Warnhinweise und Symbole

GEFAHR

Zeigt eine Situation an, die zum Tod oder schwere Verletzungen führt.

GEFAHR:STROMSCHLAG-RISIKO

Zeigt eine Situation an, die zu einem Stromschlag führen könnte.

GEFAHR:VERBRENNUNGSRISIKO

Zeigt eine Situation an, dass zu einer Verbrennung führen kann, aufgrund der extrem heißen oder tiefen Temperaturen.



WARNUNG

Zeigt eine Situation an, die zum Tod oder schwere Verletzungen führen könnte.



VORSICHT

Zeigt eine Situation an, die zu geringen Beschädigungen oder Verletzungen führen könnte.



HINWEIS

Zeigt eine Situation an, die zur Beschädigung der Geräte oder anderer Gegenstände führen könnte.



INFORMATION

Zeigt nützliche Hinweise oder zusätzliche Informationen an.

1.2 Für den Nutzer

- Falls Sie noch nicht sicher sind, wie die Einheit zu bedienen ist, kontaktieren Sie Ihren Monteur.

- Das Gerät ist nicht für den Gebrauch durch Personen, einschließlich Kinder, mit eingeschränkter körperlicher, sensorischer oder geistiger Leistungsfähigkeit oder mangelnder Erfahrung und Kenntnis bestimmt, es sei denn, sie werden von einer für ihre Sicherheit verantwortlichen Person beaufsichtigt oder erhalten Anweisungen zur Bedienung des Gerätes. Kinder müssen überwacht werden, um sicher zu sein, dass sie mit dem Produkt nicht spielen.



VORSICHT

Spülen Sie NIEMALS die Einheit. Es kann zu Stromschlägen oder Bränden führen.



HINWEIS

- Stellen Sie KEINE Gegenstände oder Geräte auf das Gerät.
- Setzen, klettern oder stehen Sie NICHT auf das Gerät.

- Die Einheit ist mit dem folgenden Symbol markiert:



Das bedeutet, dass elektrische und elektronische Produkte nicht mit dem allgemeinen Haushaltsabfall vermisch werden können. Demontieren Sie das System NIE selbst: das Demontieren des Systems, die Handhabung des Kühlmittels, des Öls und der anderen Bestandteilen müssen von einem autorisierten Monteur gehandhabt werden und den Gesetzen entsprechen. Die Einheiten müssen einer autorisierten Aufbereitungsanlage zugeführt werden, für die Wiederverwendung, das Recycling und die Verwertung. Durch eine ordnungsgemäße Entsorgung vergewissern Sie sich, dass das Produkt entsprechend entsorgt wird und mögliche negative Konsequenzen für die Umwelt und die Gesundheit vorgebeugt werden. Für mehr Informationen, kontaktieren Sie Ihren Monteur oder die lokalen Behörden.

2 EIN BLICK AUF DIE BEDIENOBERFLÄCHE

2.1 Aussehen der kabelgebundenen Fernbedienung

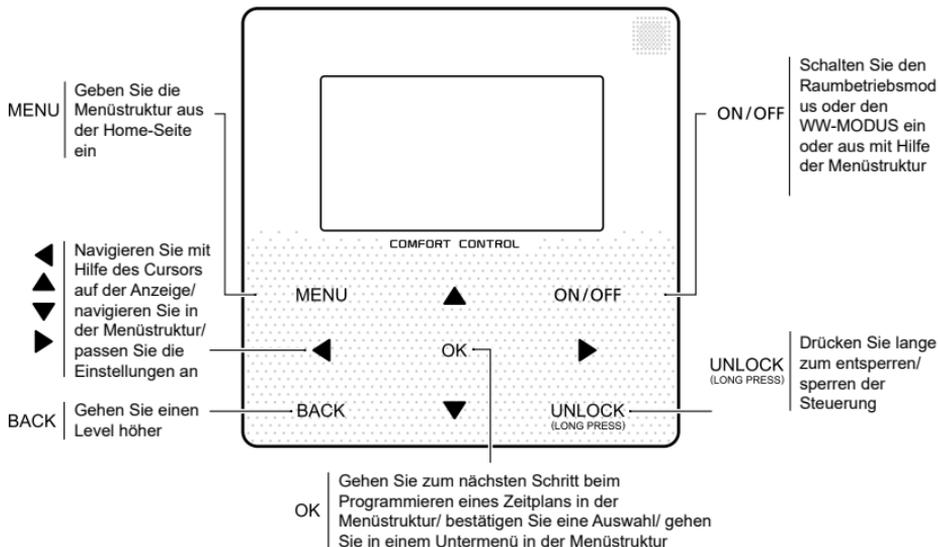

2.2 Status-Icons

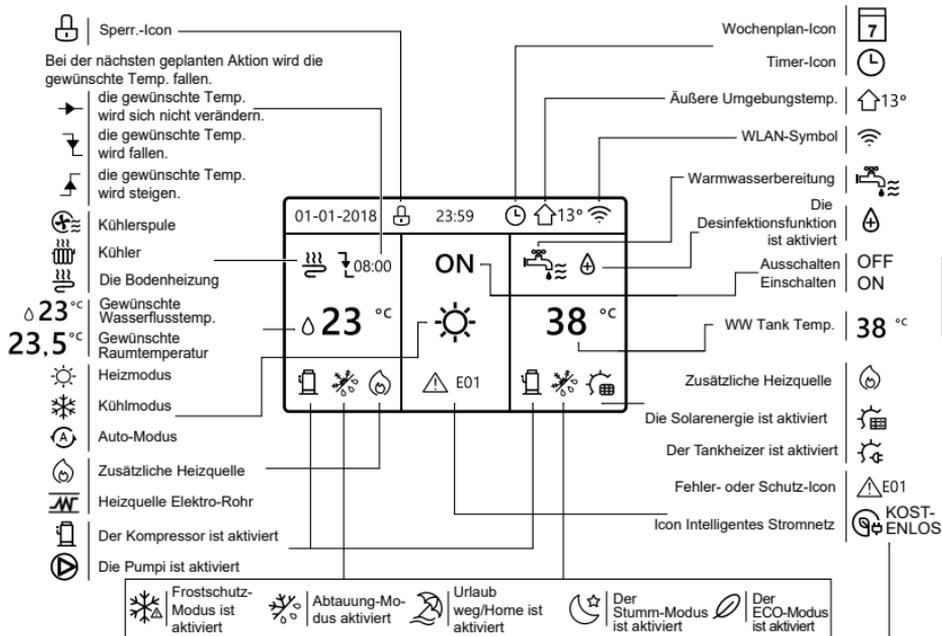

	Kühlerspule	Kühler	Die Bodenheizung	Warmwasserbereitung
ON (EIN)				
OFF (AUS)				

	Kostenlose Elektrizität	Tal-Elektrizität	Stromspitzenverbrauch
Intelligentes Stromnetz	KOSTENLOS	TAL	SPITZE

3 NUTZUNG DER HOME-SEITEN

3.1 Über Startseiten

Sie können die Home Seiten benutzen, um die Einstellungen für den täglichen Betrieb anzusehen und zu verändern. Die Anzeigen und Möglichkeiten werden, wo anwendbar, beschrieben. Je nach Systemlayout sind folgende Home-Seiten möglich:

- Gewünschte Raumtemperatur (RAUM)
- Gewünschte Wasserflusstemperatur (HAUPT)
- Ist-Temperatur des WW-Tanks (TANK)
- WW=Warmwasserbereitung

Home-Seite 1 :

IFalls die WASSERFLUSSTEMP. ist auf JA eingestellt und RAUMTEMP. ist auf KEIN. eingestellt . Das System besitzt Funktionen, einschließlich der Bodenheizung und der Wasserzubereitung, und die Home-Seite 1 wird angezeigt:

HINWEIS

Alle Bilder des Handbuches werden zu Verdeutlichungszwecken benutzt, die eigentlichen Seiten der Anzeige könnten einige Unterschiede vorweisen.

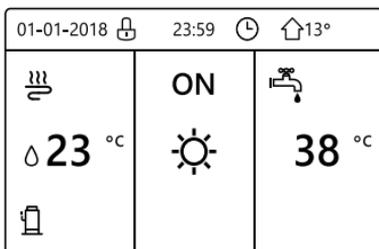

Home-Seite2 :

Falls die WASSERFLUSSTEMP. ist auf KEIN eingestellt und RAUMTEMP. ist auf JA eingestellt . Das System besitzt Funktionen, einschließlich der Bodenheizung und der Warmwasserzubereitung, und die Home-Seite 2 wird angezeigt:

HINWEIS

Die kabelgebundene Fernbedienung sollte im Raum mit der Fußbodenheizung installiert sein, um die Raumtemperatur zu prüfen.

01-01-2018 	23:59 	 13°
 23.5 °C 	ON 	 38 °C

Home-Seite3 :

Falls der WW-MODUS auf KEIN gesetzt ist, und falls "WASSERFLUSSTEMP." ist auf JA eingestellt, "RAUM-TEMP." ist auf JA gesetzt, Es wird eine Hauptseite und eine zusätzliche Seite angezeigt. Das System besitzt Funktionen zur Bodenheizung und Raumheizung für die Lüfterspule, Home-Seite 3 wird angezeigt:

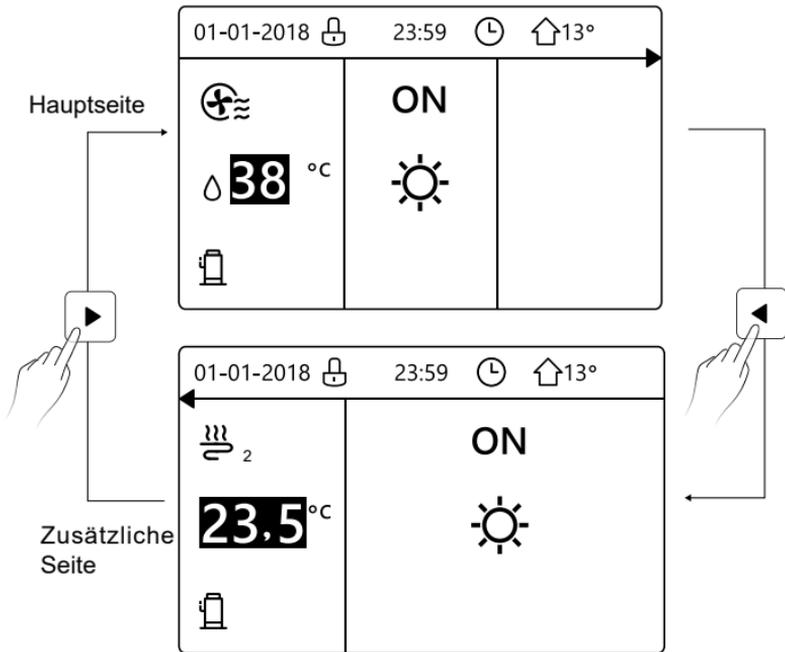

Home-Seite4 :

Falls der RAUMTHERMOSTAT auf DOPPELZONE gesetzt ist oder DOPPELZONE auf JA. Es wird eine Hauptseite und eine zusätzliche Seite angezeigt. Das System beinhaltet auch Funktionen zur Bodenkühlung, Raumkühlung für die Lüfterspule und Warmwasserbereitung, die Home-Seite 4 wird angezeigt:

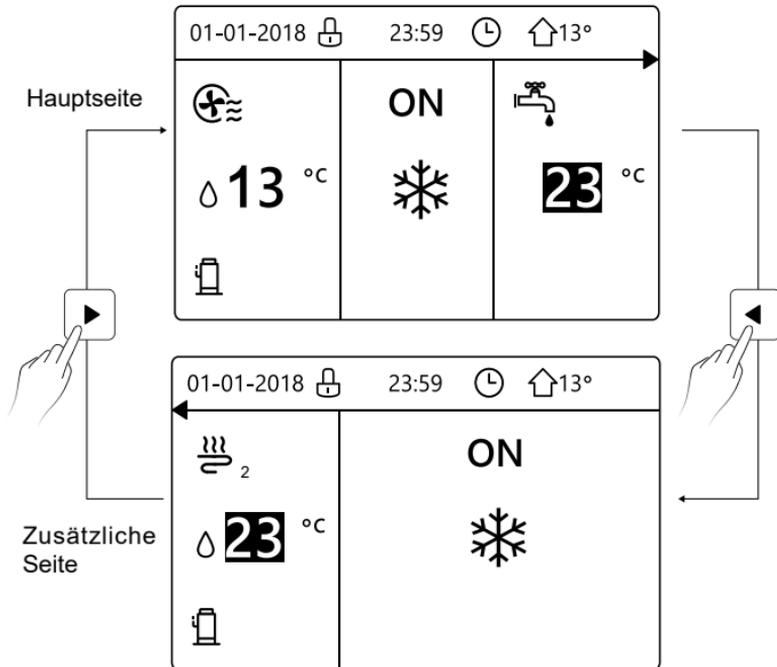

4 MENÜSTRUKTUR

4.1 Über die Menüstruktur

Sie können die Menüstruktur benutzen, um die Einstellungen, die NICHT für die tägliche Nutzung gedacht sind, zu lesen und anzupassen. Die Ansichten und die Handlungen in der Menüstruktur sind beschrieben, wo anwendbar.

4.2 Menüstruktur aufrufen

Aus der Home-Seite drücken Sie „MENÜ“. Ergebnis: die Menüstruktur wird angezeigt:

MENÜ	1/2
BETRIEBSMODUS	
SOLLTEMPERATUR	
WARMWASSERBEREIT. (WW)	
ZEITPLAN	
OPTIONEN	
KINDERSICH	
OK ENTER	↕

MENÜ	2/2
SERVICE-INFOS	
BETRIEBSPARAMETER	
FÜR TECHNIKER	
WLAN EINSTELLUNG	
OK ENTER	↕

4.3 In der Menüstruktur navigieren

Benutzen Sie "▼", "▲" zum Scrollen.

5 GRUNDBEDIENUNG

5.1 Bildschirm Entsperren.

Falls das Icon  auf dem Bildschirm sind, ist der Controller blockiert. Die folgende Seite wird angezeigt:

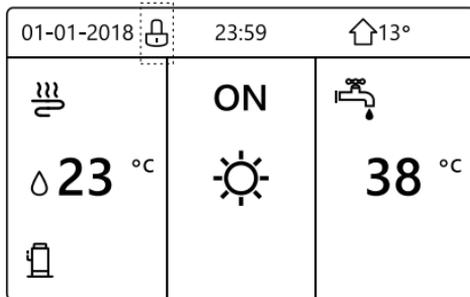

Drücken Sie eine beliebige Taste und das Icon  wird blinken. Drücken Sie die „UNLOCK“ Taste lange. Das Icon  wird verschwinden, die Schnittstelle kann gesteuert werden.

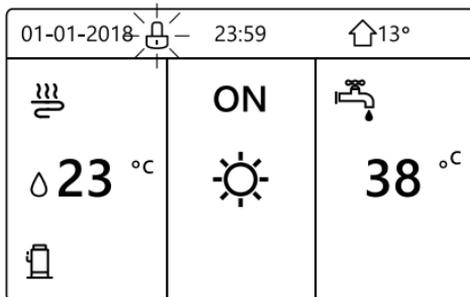

Die Schnittstelle wird gesperrt, falls eine längere Zeit keine Handlung unternommen wird (ungefähr 120 Sekunden) Falls die Schnittstelle entsperrt ist, drücken Sie lange „UNLOCK“, wird die Schnittstelle blockiert.

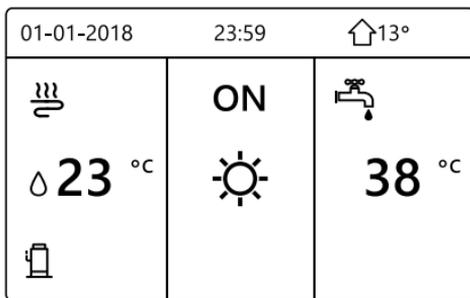

Drücken
Sie lange
UNLOCK



Drücken
Sie lange
UNLOCK

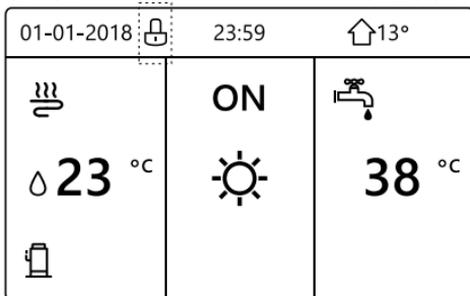

5.2 Steuerung AN/AUS

Benutzen Sie die Schnittstelle, um die Einheit für die Raum-Heizung oder -Kühlung ein- oder auszuschalten.

- Das AN/AUS der Einheit kann durch die Schnittstelle gesteuert werden, falls RAUMTHERMOSTAT auf KEIN ist (siehe „EINSTELLUNG RAUMTHERMOSTAT“ im „Installations- und Betriebsanleitung“)
- (Getrenntes Innengerät M-thermal“)

Drücken Sie "◀", "▲" auf der Home-Seite wird der schwarze Cursor angezeigt:

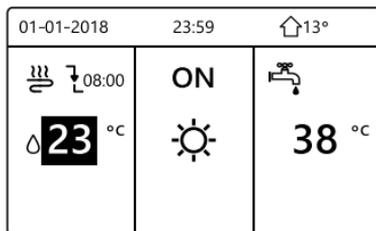

1) Wenn der Cursor auf der Temperatur des Raum-Betriebsmodus ist (einschließlich des Heizmodus  , Kühlmodus  und Auto-Modus ), drücken Sie die "ON/OFF"-Taste, um die Raum-Heizung oder -Kühlung ein-/auszuschalten.

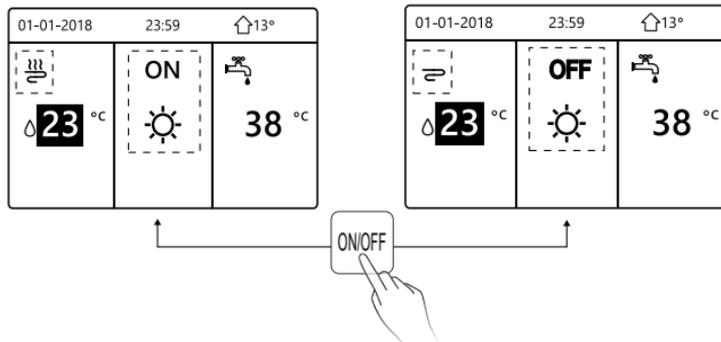

Falls der WW-TYP auf KEIN gesetzt ist, werden folgende Seiten Folgendes anzeigen:

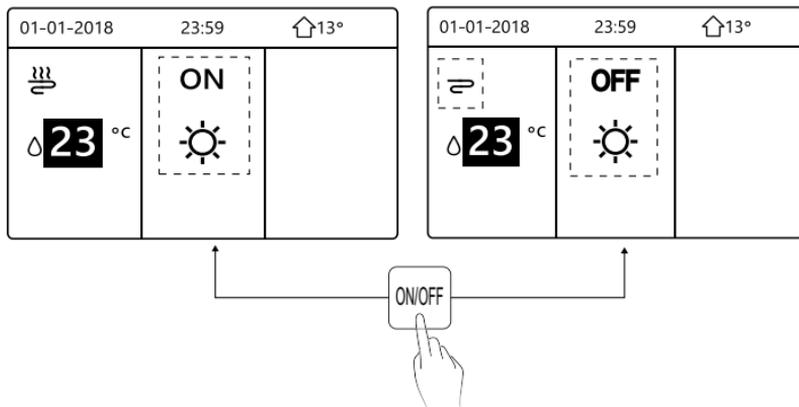

Falls der TEMP.-TYP auf RAUM-TEMP. gesetzt ist, werden folgende Seiten Folgendes anzeigen:

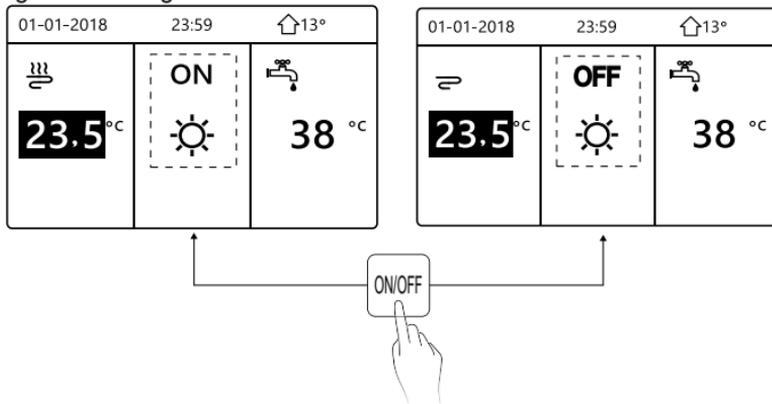

Benutzen Sie den Raumthermostat, um die Einheit für die Raum-Heizung oder -Kühlung ein- oder auszuschalten.

① Der Raumthermostat ist auf KEIN GESETZT (siehe „EINSTELLUNGEN DES RAUMTHERMOSTATS“ in der „Installations- und Betriebsanleitung (Getrenntes Innengerät M-thermal)“). Die Einheit der Raumheizung oder -kühlung wird vom Raumthermostat ein- oder ausgeschaltet, Drücken Sie ON/OFF auf der Schnittstelle, und Folgendes wird angezeigt:

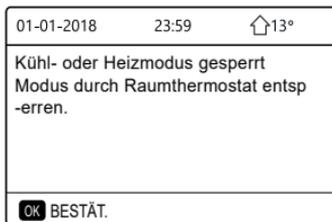

② Der Raumthermostat ist auf DOPPELZONE GESETZT (siehe „EINSTELLUNG RAUMTHERMOSTAT“ in der „Installations- und Betriebsanleitung (Getrenntes Innengerät M-thermal)“). Der Raumthermostat oder Lüfterspule ist ausgeschaltet, der Raumthermostat für die Bodenheizung ist eingeschaltet und die Einheit funktioniert, aber das Display ist OFF. Folgende Seite wird angezeigt:

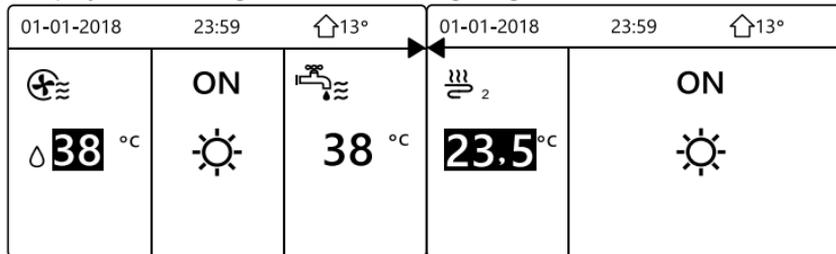

01-01-2018 23:59  13°			01-01-2018 23:59  13°		
	OFF			OFF	
 38 °C		38 °C	23.5 °C		

Benutzen Sie die Schnittstelle, um die Einheit für WW ein- oder auszuschalten. Drücken Sie „►“, „▼“ auf der Home-Seite wird der schwarze Cursor angezeigt:

01-01-2018 23:59  13°		
	ON	
 23 °C		38 °C

2) Wenn der Cursor auf der Temperatur im WW-Modus ist. Drücken Sie die „ON/OFF“-Taste, um den WW-Modus ein-/auszuschalten.

Der Raum-Betriebsmodus ist ON, danach werden folgende Seiten angezeigt:

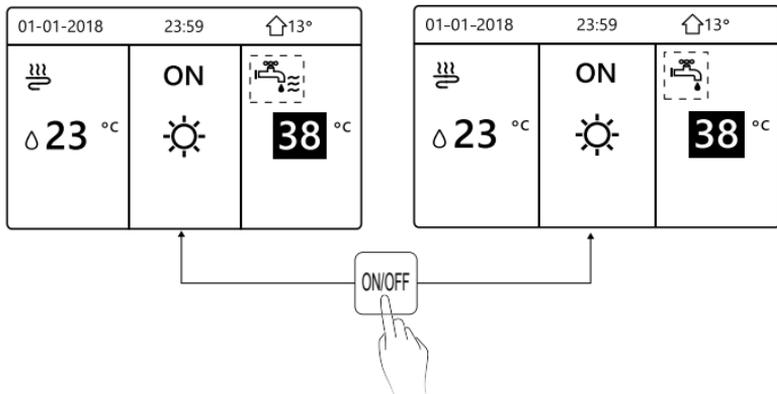

Der Raum-Betriebsmodus ist OFF, danach werden folgende Seiten angezeigt:

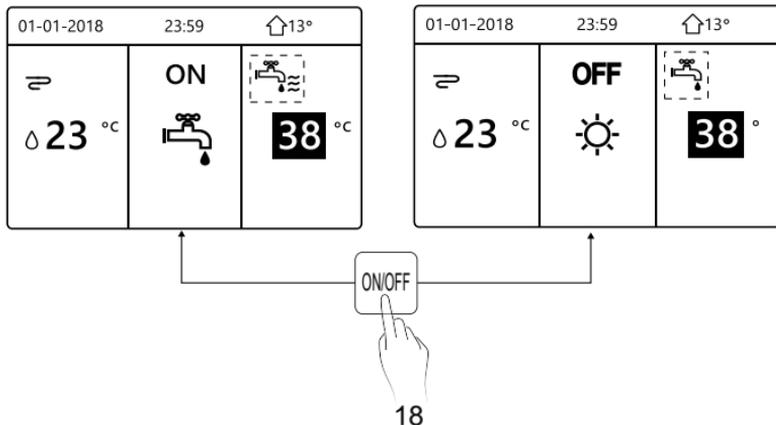

5.3 Temperatur anpassen

Drücken Sie „◀“, „▲“ auf der Home-Seite wird der schwarze Cursor angezeigt:

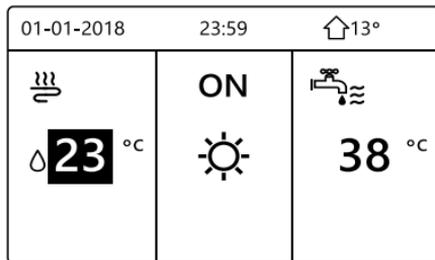

- Falls der Cursor auf der Temperatur ist, benutzen Sie „◀“, „▶“ zum Auswählen und benutzen Sie „▼“, „▲“ um die Temperatur einzustellen.

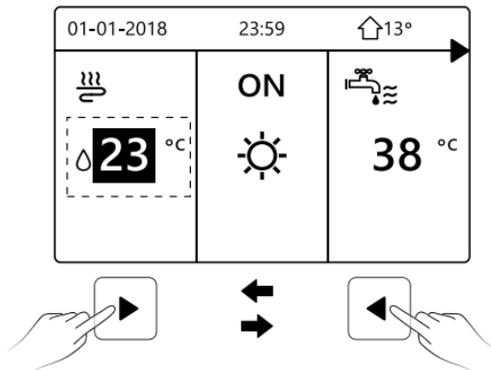

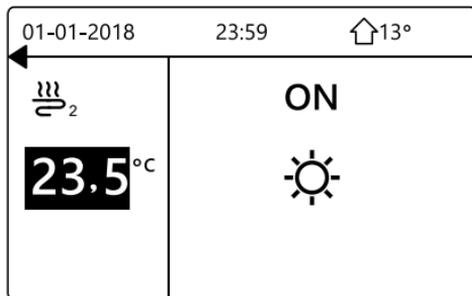
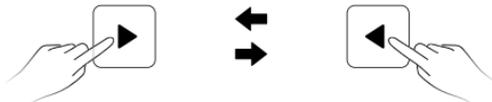
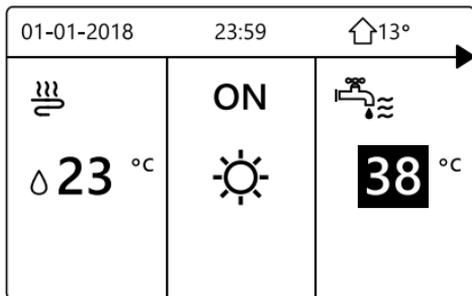

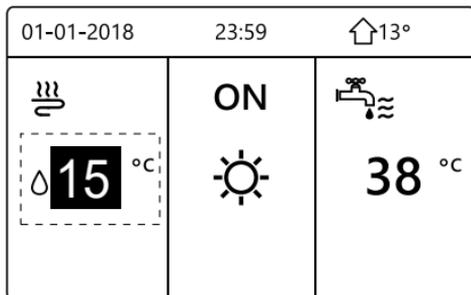
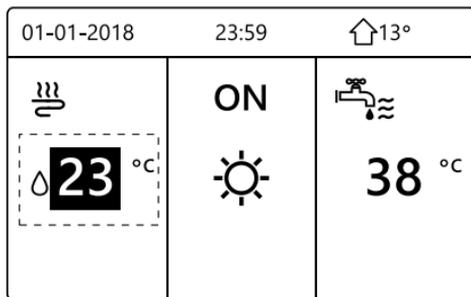

5.4 Raumbetriebsmodus anpassen

- Anpassung des Raumbetriebsmodus durch die Schnittstelle Gehen Sie zu „MENÜ“ > „BETRIEBSMODUS“ . Drücken Sie „OK“, folgendes wird angezeigt:

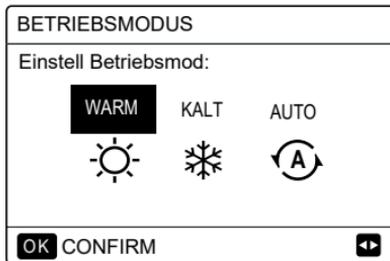

- Es gibt drei Modi, die gewählt sind, einschließlich den HEIZ-, KÜHL- und AUTO-Modus. Benutzen Sie „◀“, „▶“ zum Scrollen, drücken Sie danach „OK“ zum Auswählen. Auch wenn Sie die OK-Taste nicht drücken und die Seite verlassen, indem Sie die BACK-Taste drücken, der Modus wird trotzdem aktiv sein, falls der Cursor im Betriebsmodus bewegt wurde.

Falls es nur einen HEIZ(KÜHL)-Modus gibt, wird folgende Seite wird angezeigt:

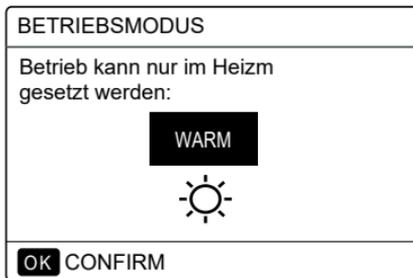

- Der Betriebsmodus kann nicht verändert werden.

Falls Sie wählen...	Dann ist der Raum-Betriebsmodus ..
 HEAT (HEIZEN)	Immer Heizmodus
 COOL (KÜHLEN)	Immer Kühlmodus
 AUTO	<p>Automatisch von der Software verändert, aufgrund der Außentemperatur (und entsprechend den Montage-Einstellungen für die Innentemperatur) und nimmt die monatlichen Einschränkungen in Betracht. Hinweis: Die automatische Änderung ist nur unter bestimmten Umständen möglich. Siehe „FÜR TECHNIKER“ > „AUTO-MODUS EINSTELLUNG“ in der „Installations- und Betriebsanleitung (Getrenntes Innengerät M-thermal)“.</p>

- Passen Sie den Betriebsmodus mit Hilfe des Raumthermostats an, siehe „RAUMTHERMOSTAT“ im „Installations- und Betriebsanleitung (Getrenntes Innengerät M-thermal)“.
Gehen Sie in "MENÜ">"BETRIEBSMODUS", falls Sie eine Taste zum Auswählen oder Anpassen drücken, wird folgende Seite angezeigt:

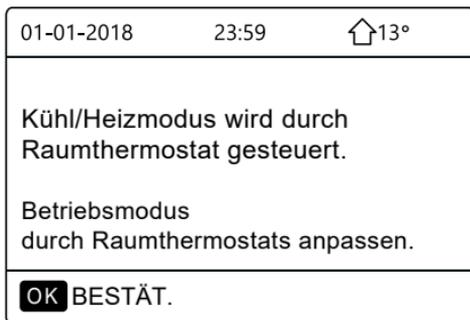

6 Netzwerk-Konfigurationsanweisungen

- Der kabelgebundene Controller sichert die intelligente Steuerung des eingebauten Moduls, dass das Steuersignal von der APP erhält.
- Bevor Sie den WLAN verbinden, prüfen Sie bitte, ob der Router in Ihrem Umfeld aktiv ist und vergewissern Sie sich, dass der kabelgebundene Controller gut am kabellosen Signal verbunden ist.
- Während des kabellosen Verteilungsprozess, blinkt das LCD-Symbol "  " um anzuzeigen, dass das Netzwerk eingesetzt wird. Nachdem der Prozess abgeschlossen ist, wird das Symbol "  " durchgehend ein sein.

6.1 Einstellungen des kabelgebundenen Controllers

Die Einstellungen des kabelgebundenen Controllers schließen den AP-MODUS und WLAN EINSTELLUNG ZURÜCKSETZEN.

WLAN EINSTELLUNG
AP MODE
WLAN-EINST. WIEDERHERSTELLEN
OK ENTER 

- Aktivieren Sie das WLAN über die Schnittstelle. Gehen Sie auf "MENÜ" > "WLAN EINSTELLUNG" > "AP MODUS". Drücken Sie "OK", folgende Seite wird angezeigt:

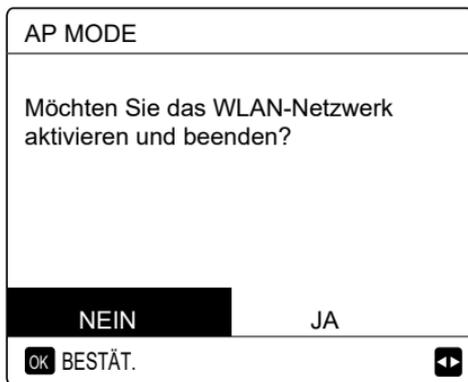

Benutzen Sie "◀", "▶" um auf "JA" zu gehen, drücken Sie "OK", um den AP-Modus auszuwählen. Wählen Sie den AP-Modus entsprechend auf das mobile Gerät und fahren Sie mit den Follow-UP Einstellungen, entsprechend den APP-Anweisungen fort.

VORSICHT

Nachdem Sie den AP-Modus aufrufen, falls es am Mobiltelefon nicht verbunden ist, wird das LCD-Symbol "📶" 10 Minuten lang blinken und danach verschwinden. Falls es am Mobiltelefon verbunden ist, wird das Symbol "📶" durchgehend angezeigt.

- WLAN Einstellung über die Schnittstelle zurücksetzen.
Gehen Sie im "MENÜ" > "WLAN EINSTELLUNG" > "WLAN EINSTELLUNG ZURÜCKSETZEN".
Drücken Sie „OK“, folgende Seite wird angezeigt:

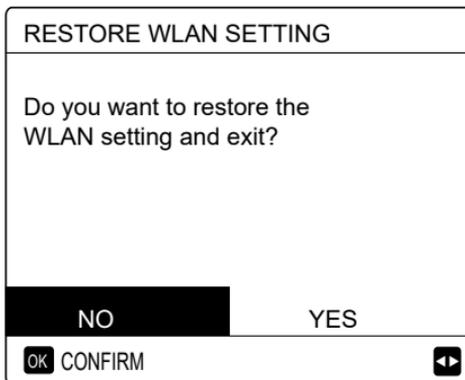

Benutzen Sie "◀", "▶" um auf „JA“ zu gehen, drücken Sie „OK“, um die WLAN Einstellungen zurückzusetzen. Beenden Sie die vorhin angegebene Funktion und die kabellose Konfiguration ist zurückgesetzt.

6.2 Einstellung des mobilen Gerätes

Der AP-Modus ist für die kabellose Verteilung auf das mobile Gerät verfügbar.

- Verbindung des AP Modus am WLAN:

6.2.1 APP installieren

- ① Scannen Sie den folgenden QR-Code, um die Smart Home APP zu installieren.



- ② Suchen Sie bitte erneut nach "MSma tLife" im APP STORE oder GOOGLE PLAY, um die APP zu installieren.

Diese APP gilt nur für Android 7.0 und IOS7 oder neuere Betriebssysteme.

6.2.2 Anmelden/Registrieren

Bitte geben Sie Ihren Registrierungscode ein. Oder scannen Sie den QR-Code auf der Verpackungsbox des Controllers, falls vorhanden. Und registrieren Sie Ihr Konto gemäß den Anweisungen.

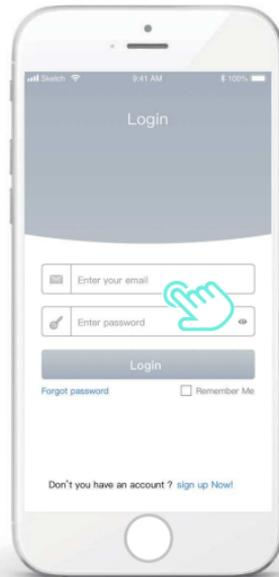
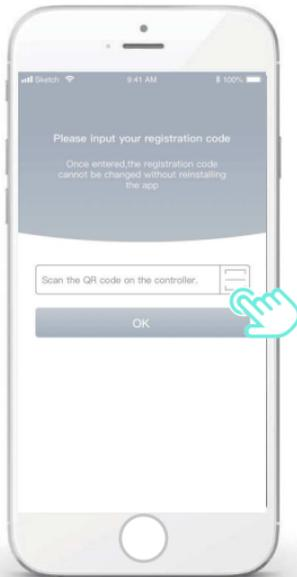

6.2.3 Haushaltsgeräte hinzufügen:

1) Fügen Sie Ihr Gerät gemäß den Anweisungen hinzu.

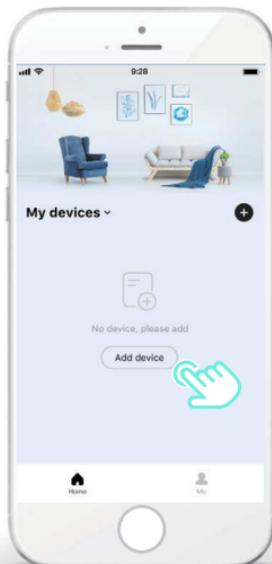

2) Betreiben Sie den kabelgebundenen Controller entsprechend den APP Anweisungen.



3) Warten Sie darauf, dass das Haushaltsgerät verbunden ist, und klicken Sie auf „Complete“.

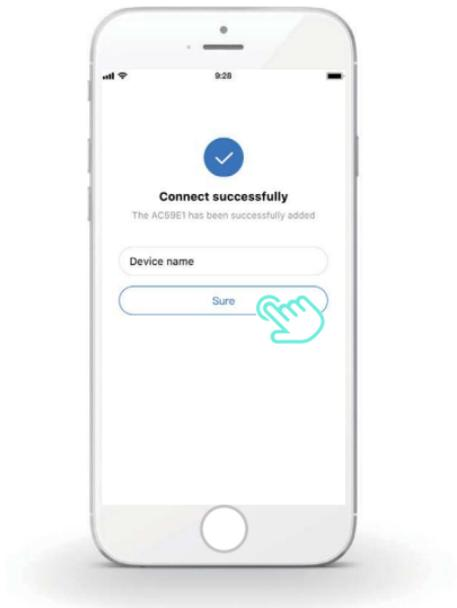

- 4) Nachdem das Haushaltsgerät erfolgreich verbunden wurde, wird das LCD-Symbol “” des kabelgebundenen Controllers durchgehend ein sein, und die Klimaanlage kann über die APP gesteuert werden.
- 5) Falls der Prozess der Verbindung zum Netzwerk erfolglos ist, oder die mobile Verbindung eine Neuverbindung und Ersetzen verlangt, betätigen Sie „WLAN auf Werkseinstellungen zurücksetzen“ auf den kabelgebundenen Controller, und wiederholen Sie den Prozess.

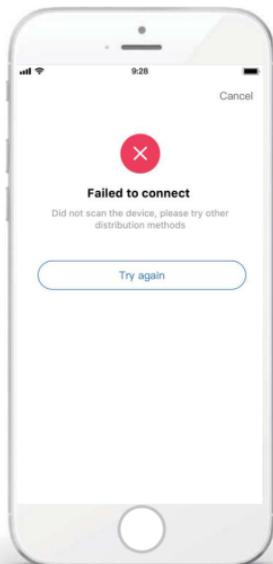



Warnung und Fehlersuche für Netzerkausfälle

Wenn das Produkt am Netzwerk verbunden ist, vergewissern Sie sich bitte, dass das Telefon so nahe wie möglich am Produkt ist.

Wir unterstützen zur Zeit nur Router mit einem 2,4GHz Band.

Sonderzeichen (Satzzeichen, Leerzeichen usw.) werden im Namen des WLAN nicht empfohlen

Wir empfehlen Ihnen die Verbindung von maximal 10 Geräten an einem einzigen Router, da ansonsten die Haushaltsgeräte durch den schwachen und instabilen Netzwerkeempfang beeinflusst werden.

Falls das Passwort auf dem Router oder WLAN Netzwerk verändert wird, löschen Sie alle Einstellungen und Setzen Sie das Gerät zurück.

Der Inhalt der APP kann aufgrund von Aktualisierungen der Version verändert werden, und die aktuelle Betriebsweise wird vorrangig sein.

7. INSTALLATIONSANLEITUNG

7.1 Sicherheitsvorkehrungen

- Lesen Sie die Sicherheitshinweise sorgfältig durch, bevor Sie das Gerät installieren.
- Im Folgenden werden wichtige Sicherheitsfragen aufgeführt, die beachtet werden müssen.
- Beachten Sie, dass es während des Testbetriebs, nach Fertigstellung keine anormalen Phänomene gibt, und übergeben Sie dann das Handbuch dem Benutzer.
- Bedeutung der Markierungen:



WARNUNG

Eine unsachgemäße Handhabung kann zum Tod oder zu schweren Verletzungen führen.



VORSICHT

Eine unsachgemäße Handhabung kann zu Personenschäden oder Sachschäden führen.



WARNUNG

Bitte beauftragen Sie den Händler oder Fachleute mit der Installation des Gerätes.

Die Installation durch andere Personen kann zu fehlerhafter Installation, Stromschlag oder Feuer führen.

Befolgen Sie diese Anleitung genau.

Unsachgemäße Installation kann zu Stromschlag oder Feuer führen.

Die Neuinstallation muss von Fachleuten durchgeführt werden.

Unsachgemäße Installation kann zu Stromschlag oder Feuer führen.

Zerlegen Sie Ihre Klimaanlage nicht nach Belieben.

Eine zufällige Demontage kann zu ungewöhnlichem Betrieb oder Erwärmung führen, was zu einem Brand führen kann.

VORSICHT

Installieren Sie das Gerät nicht an einem Ort, der durch das Austreten von brennbaren Gasen gefährdet ist.

Sobald brennbare Gase austreten und um die kabelgebundene Steuerung herum verbleiben, kann ein Brand entstehen.

Die Verdrahtung sollte sich an den verdrahteten Steuerstrom anpassen.

Andernfalls kann es zu Stromausfällen oder Erwärmung kommen, die zu einem Brand führen können.

Die angegebenen Kabel sind in der Verkabelung zu verwenden. Es darf keine äußere Kraft auf die Klemme ausgeübt werden.

Andernfalls können Drahtbruch und Erwärmung auftreten und zu einem Brand führen.

Platzieren Sie die kabelgebundene Fernbedienung nicht in der Nähe der Lampen, um zu vermeiden, dass das Fernsignal der Steuerung gestört wird. (siehe rechte Abbildung)

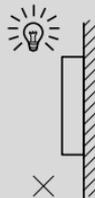

7.2 Andere Vorsichtsmaßnahmen

7.2.1 Einbauort

Installieren Sie das Gerät nicht an einem Ort mit viel Öl, Dampf und Sulfid-Gas.

Andernfalls kann sich das Produkt verformen und ausfallen.

7.2.2 Vorbereitung vor der Installation

1) Überprüfen Sie, ob die folgenden Baugruppen vollständig sind.

Nr.	Name	Anz.	Hinweise
1	Kabelgebundene Fernbedienung	1	_____
2	Kreuzrundkopf-Holzschraube	3	Für die Wandmontage
3	Kreuzrundkopf-Montageschraube	2	Zur Montage am elektrischen Schaltkasten
4	Installations- und Betriebsanleitung	1	_____
5	Kunststoffschraube	2	Dieses Zubehör wird verwendet, wenn die zentrale Steuerung im Schaltschrank installiert wird.
6	Kunststoff-Dübel	3	Für die Wandmontage

7.2.3 Hinweis zur Installation der kabelgebundenen Steuerung:

- 1) Dieses Installationshandbuch enthält Informationen über die Vorgehensweise bei der Installation der Kabelfernbedienung. Informationen zur Verbindung zwischen kabelgebundener Fernbedienung und Innengerät finden Sie in der Installationsanleitung für das Innengerät.
- 2) Der Stromkreis der kabelgebundenen Fernbedienung ist ein Niederspannungskreis. Schließen Sie es niemals an einen 220V/380V-Standardkreis an oder stecken Sie es nie im gleichen Kabelrohr mit dem Stromkreis.
- 3) Das abgeschirmte Kabel muss stabil mit der Erde verbunden sein, da sonst die Übertragung ausfallen kann.
- 4) Versuchen Sie nicht, das geschirmte Kabel durch Abschneiden zu verlängern, falls erforderlich, verwenden Sie die Klemmleiste für den Anschluss.
- 5) Verwenden Sie nach dem Anschluss Megger, um die Isolationsprüfung für die Signalleitung durchführen zu lassen.

7.3 Installationsverfahren und Anpassung der Einstellung der kabelgebundenen Steuerung

7.3.1 Strukturgrößenwert

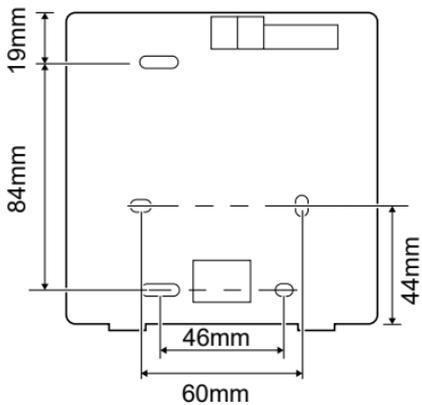
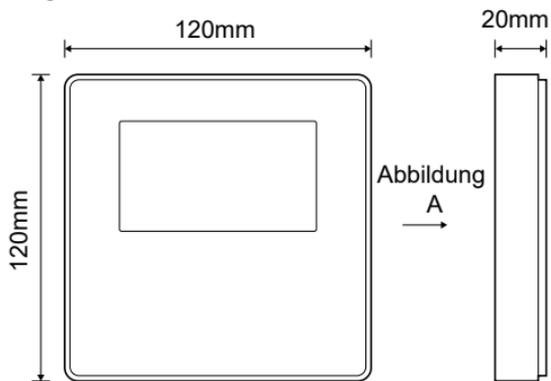

7.3.2 Verkabelung

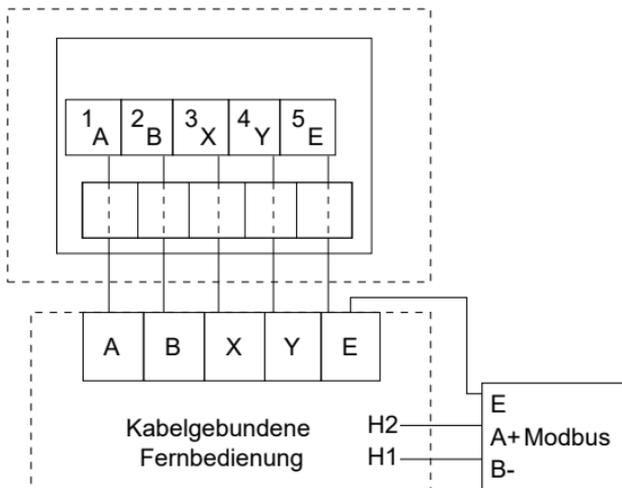

Eingangsspannung (A/B)	13,5 VAC
Kabelquerschnitt	0,75 mm ²

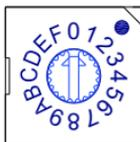

Der Drehschalter zum Kodieren S3(0-F) auf der Hauptsteuerplatte des Hydraulikmoduls dient zum Einstellen der Modbus-Adresse.

Standardmäßig haben die Geräte diesen Kodierschalter auf Position=0, aber das entspricht der Modbus-Adresse 16, während die anderen Positionen der Nummer entsprechen, z.B. Pos. =2 ist Adresse 2, Pos.=5 ist Adresse 5.

7.3.3 Montage der Rückwand

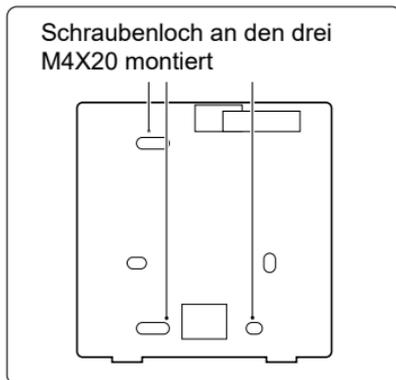
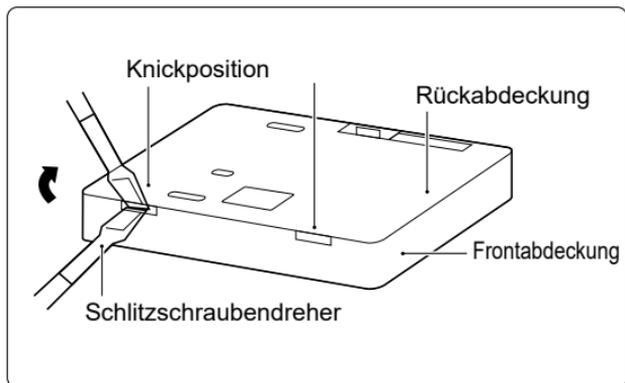

Schraubenloch an den drei
M4X20 montiert

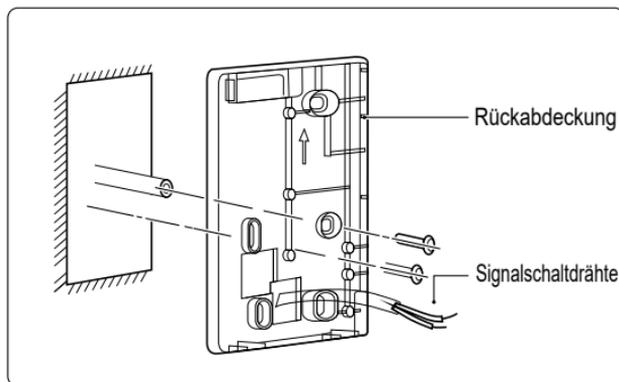

- 1) Verwenden Sie einen geraden Schraubendreher, um in die Knickstellung im unteren Teil der kabelgebundenen Steuerung einzuführen, und drehen Sie den Schraubendreher, um die hintere Abdeckung abzunehmen. (Achten Sie auf die Drehrichtung, da sonst die Rückseite beschädigt wird!)
- 2) Verwenden Sie drei M4X20 Schrauben, um die Rückwand direkt an der Wand zu befestigen.
- 3) Montieren Sie die Rückabdeckung mit zwei M4X25 Schrauben am 86er Elektrokasten und verwenden Sie eine M4X20 Schraube zur Befestigung an der Wand.
- 4) Stellen Sie die Länge von zwei Kunststoffschraubleisten im Zubehör als Standardlänge von der Elektrokastenschraubstange bis zur Wand ein. Achten Sie bei der Montage der Schraubleiste an der Wand darauf, dass sie so flach wie die Wand ist.
- 5) Befestigen Sie die untere Abdeckung der kabelgebundenen Fernbedienung mit Kreuzschlitzschrauben an der Wand durch die Schraubleiste. Vergewissern Sie sich, dass sich die untere Abdeckung der kabelgebundenen Fernbedienung nach der Installation auf gleicher Höhe befindet, und installieren Sie die kabelgebundene Fernbedienung dann wieder auf der unteren Abdeckung.
- 6) Eine übermäßige Befestigung der Schraube führt zu einer Verformung der Rückabdeckung.

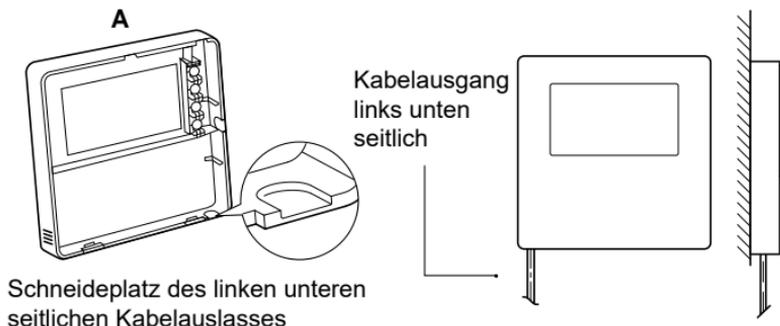

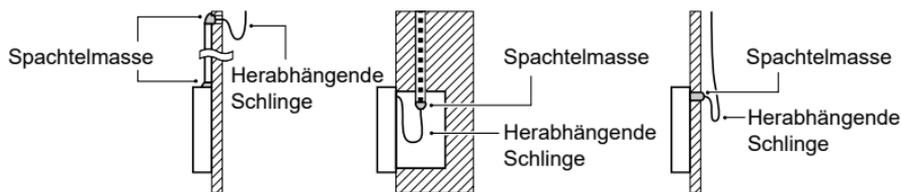
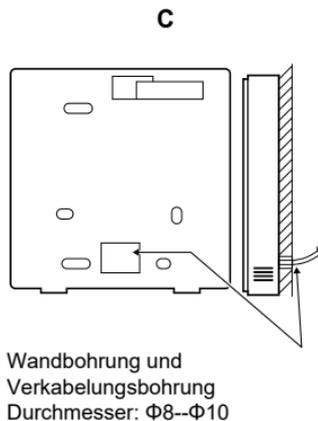
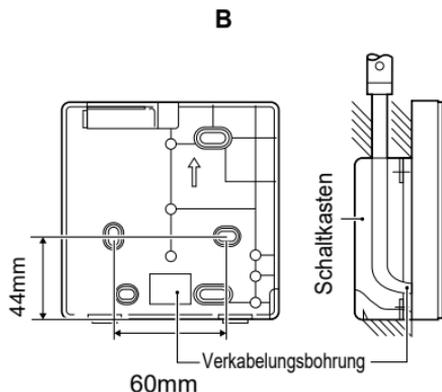

Vermeiden Sie, dass Wasser in die kabelgebundene Fernbedienung eindringt, verwenden Sie eine herabhängende Schlinge und Spachtelmasse, um die Kabelstecker bei der Kabelinstallation abzudichten.

7.4 Montage der Frontabdeckung

Nach dem Anpassen der Frontabdeckung schließen Sie sie; klemmen Sie das Kommunikationskabel während der Installation nicht ein.

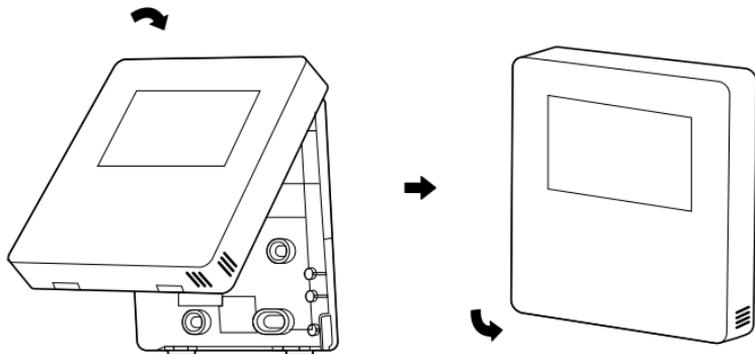

Der Sensor kann nicht durch Feuchtigkeit beeinflusst werden.

Montieren Sie die hintere Abdeckung richtig und schließen Sie die vordere Abdeckung und die hintere Abdeckung fest, da sonst die vordere Abdeckung herunterfällt.



- Bu kılavuz, çalışma sırasında dikkat etmeniz gereken önlemlerin ayrıntılı açıklamasını sunar.
- Kablolu kontrolörün doğru servisini garantilemek için lütfen üniteyi kullanmadan önce bu kılavuzu dikkatle okuyun.
- Gelecekte referans almayı kolaylaştırmak için kurduktan sonra bu kılavuzu saklayın.

İÇİNDEKİLER

1 GENEL GÜVENLİK ÖNLEMLERİ

- 1.1 Doküman hakkında 1
- 1.2 Kullanıcı için 2

2 KULLANICI ARAYÜZÜNE GENEL BAKIŞ

- 2.1 Kablolu kontrolörün görünümü 5
- 2.2 Durum simgeleri 6

3 ANASAYFALARIN KULLANIMI

- 3.1 Ana sayfalar hakkında 7

4 MENÜ YAPISI

- 4.1 Menü yapısı hakkında 11
- 4.2 Menü yapısına gitmek için 11
- 4.3 Menü yapısında gezinmek için 11

5 TEMEL KULLANIM

- 5.1 Ekran Kilidini Açma 12
- 5.2 Kontrolleri AÇIK/KAPALI konuma getirme 14
- 5.3 Sıcaklığı ayarlama 19
- 5.4 Alan çalışma modunu ayarlama 22

6 Ağ Yapılandırma Kuralları

- 6.1 Kablolu Kumanda Ayarı 25
- 6.2 Mobil Cihaz Ayarı 28

7 KURULUM KILAVUZU

- 7.1 Güvenlik önlemleri 35
- 7.2 Diğer önlemler 38
- 7.3 Kurulum prosedürü ve kablolu kumandayla uyumlu ayar 39
- 7.4 Ön kapağın takılması 46

1 GENEL GÜVENLİK ÖNLEMLERİ

1.1 Doküman hakkında

- Orijinal belge, İngilizce yazılmıştır. Diğer tüm dillerdeki belgeler çeviridir.
- Bu dokümanda açıklanan önlemler oldukça önemli konuları kapsar, bunları dikkatle izleyin.
- Kurulum kılavuzunda açıklanan tüm işlemler, yetkili bir kurucu tarafından gerçekleştirilmelidir.

1.1.1 Uyarıların ve sembollerin anlamı

TEHLİKE

Ölüm veya ciddi yaralanmaya yol açan bir durum belirtir.

TEHLİKE:ELEKTRİK ÇARPMASI RİSKİ

Elektrik çarpmasına yol açabilecek bir durum belirtir.

TEHLİKE:YANMA RİSKİ

Aşırı sıcak veya soğuk sıcaklıklar nedeniyle yanmaya yol açabilecek bir durum belirtir.

DİKKAT

Ölüm veya ciddi yaralanmaya yol açabilecek bir durum belirtir.

DİKKAT

Küçük veya orta düzeyde yaralanmaya yol açabilecek bir durum belirtir.

NOT

Ekipman veya özelliklerde hasara yol açabilecek bir durum belirtir.

BİLGİ

Kullanışlı ipuçları veya ilave bilgileri belirtir.

1.2 Kullanıcı için

- Üniteyi nasıl çalıştıracığınızdan emin değilseniz kurucunuzla iletişime geçin.

- Cihaz, güvenliklerinden sorumlu bir kiři tarafından kendilerine cihazın kullanımıyla iliřkili nezaret edilmedięi veya talimatlar verilmedięi takdirde, çocuklar da dahil olmak üzere, kısıtlı fiziksel, duyuusal veya zihinsel kabiliyetlere ya da deneyim ve bilgi eksiklięine sahip kiřiler tarafından kullanılmak üzere tasarlanmamıřtır. Ürünle oynamadıklarından emin olmak için çocuklar gözetim altında tutulmalıdır.



CAUTION

Üniteyi YIKAMAYINIZ. Bu, elektrik çarpmasına veya yangına yol açabilir.



NOT

- Ünitenin üzerine herhangi bir nesne veya ekipman KOYMAYIN.
- TIRMANMAYIN veya AYAĞINIZLA BASMAYIN.

- Üniteler, aşağıdaki sembolle işaretlenmiştir:



Bu, elektrik ve elektronik ürünlerin sınıflandırılmamış evsel atıklarla karıştırılmayacağı anlamına gelir. Sistemi kendiniz sökmeye **ÇALIŞMAYINIZ**: Sistemin sökülmesi, soğutma sıvısının, yağın ve diğer parçaların bakımı yetkili bir kurucu tarafından yapılmalı ve geçerli mevzuatla uyumlu olmalıdır. Ünitelerin bakımı, yeniden kullanım, geri dönüşüm ve kurtarma için özel bir bakım tesisinde yapılmalıdır. Bu ürünün doğru şekilde ortadan kaldırıldığından emin olarak, çevre ve insan sağlığı için muhtemel olumsuz sonuçları önlemeye yardımcı olacaksınız. Daha fazla bilgi için, kurucunuzla veya yerel yetkilinizle iletişime geçin.

2 KULLANICI ARAYÜZÜNE BİR BAKIŞ

2.1 Kablolu kontrolörün görünümü

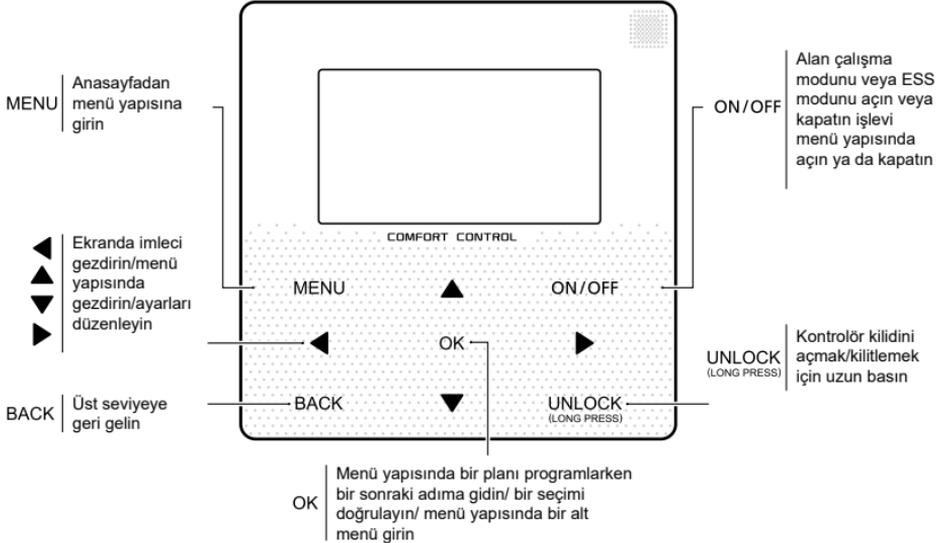

2.2 Durum simgeleri

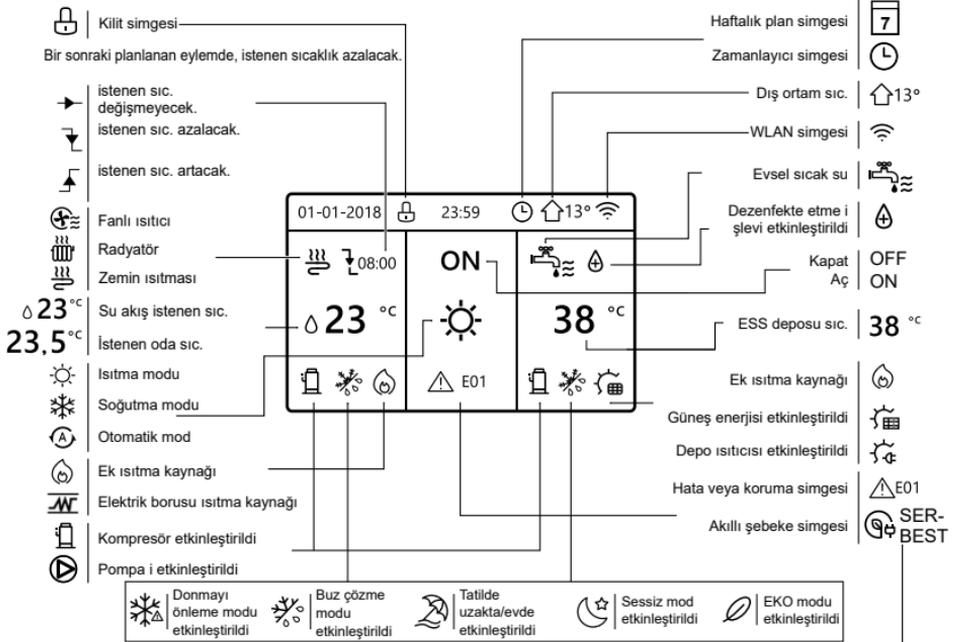

	Fanlı ısıtıcı	Radyatör	Zemin ısıtması	Evsel sıcak su
ON (AÇIK)				
OFF (KAPALI)				

	Serbest elektrik	Koyak elektrik	Doruk elektrik
Akıllı şebeke			

3 ANASAYFALARIN KULLANIMI

3.1 Ana sayfalar hakkında

Günlük kullanım amaçlı ayarları okumak ve değiştirmek için anasayfaları kullanabilirsiniz. Anasayfalarda ne görebileceğiniz ve yapabileceğiniz, geçerli olduğu durumlarda açıklanmıştır. Sistem düzenine bağlı olarak, aşağıdaki anasayfalar mümkün olabilir:

- İstenen oda sıcaklığı (ODA)
- Su akış istenen sıcaklığı (ANA)
- ESS deposu asıl sıcaklık (DEPO)

ESS=evsel sıcak su

anasayfa1:

ISU AKIŞ SIC., EVET ve ODA SIC., YOK olarak ayarlandıysa (Bkz. "Kurulum ve kullanıcı kılavuzu . Sistem, zemin ısıtma ve evsel su dahil olmak üzere işleve sahiptir, anasayfa 1 görüntülenir:

NOT

Kılavuzdaki tüm resimler açıklamak için kullanılmıştır, ekrandaki asıl sayfalarda bazı farklılıklar olabilir.

01-01-2018 	23:59 	 13°
 23 °C 	ON 	 38 °C

anasayfa2 :

SU AKIŞ SIC., YOK ve ODA SIC., EVET olarak ayarlandıysa (Bkz. "Kurulum ve kullanıcı kılavuzu Sistem, zemin ısıtma ve evsel sıcak su dahil olmak üzere işleve sahiptir, anasayfa 2 görüntülenir:

NOT

Kablolu kontrolör, oda sıcaklığını kontrol etmek için zemin ısıtma odasına kurulmalıdır.

01-01-2018 	23:59 	 13°
 23.5 °C 	ON 	 38 °C

anasayfa3:

ESS MODU, YOK olarak ve "SU AKIŞ SIC." EVET, "ODA SIC." EVET olarak ayarlandıysa, ana sayfa ve ek sayfa olacaktır. Sistem, zemin ısıtma ve alan ısıtma dahil olmak üzere fanlı ısıtma için işleve sahiptir, anasayfa 3 görüntülenir:

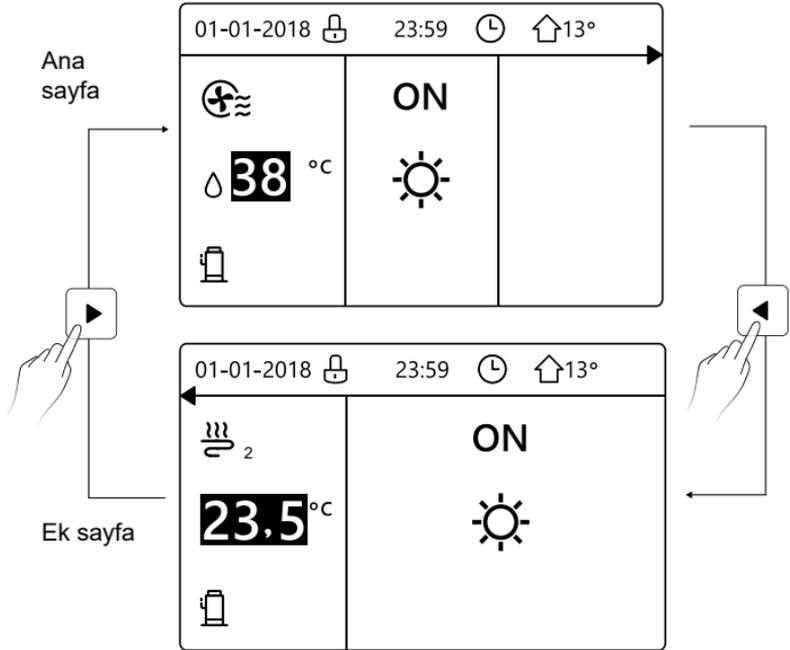

anasayfa4:

ODA TERMOSTATI, ÇİFT BÖLGE olarak veya ÇİFT BÖLGE, EVET olarak ayarlandıysa, ana sayfa ve ek sayfa olacaktır. Sistem, zemin soğutma, alan soğutma dahil olmak üzere fanlı ısıtma ve evsel sıcak su için işleve sahiptir, anasayfa 4 görüntülenir:

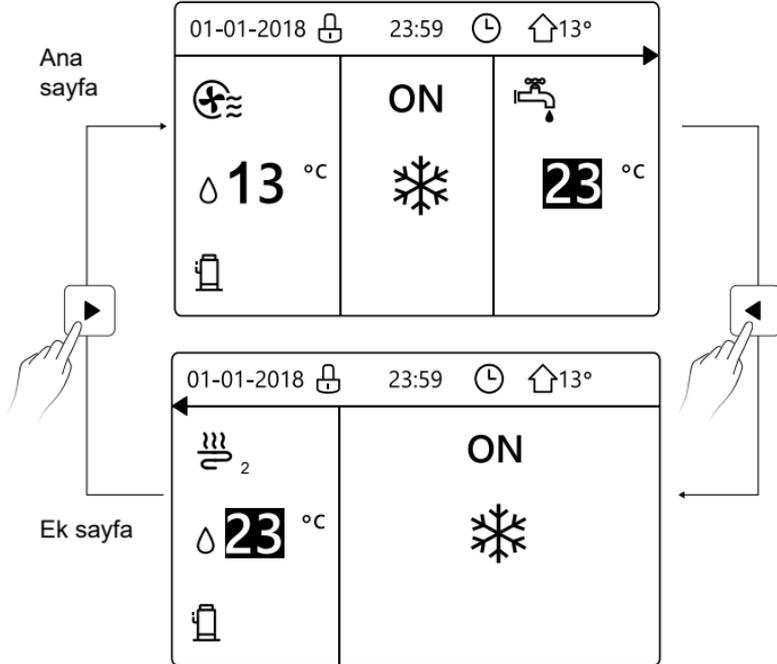

4 MENÜ YAPISI

4.1 Menü yapısı hakkında

Günlük kullanım amaçlı OLMAYAN ayarları okumak ve yapılandırmak için menü yapısını kullanabilirsiniz. Menü yapısında ne görebileceğiniz ve yapabileceğiniz, geçerli olduğu durumlarda açıklanmıştır.

4.2 Menü yapısına gitmek için

Bir anasayfadan "MENÜ" ögesine basın.Sonuç: Menü yapısı görünür:

MENÜ	1/2
ÇALIŞMA MODU	
ÖN AYARLI SICAKLIK	
EVSEL SICAK SU (ESS)	
PLAN	
SEÇENEKLER	
ÇOCUK KİLİDİ	
OK GİRİŞ	⌵

MENÜ	2/2
SERVİS BİLGİSİ	
ÇALIŞMA PARAMETRESİ	
SERVİS ÇALIŞANI İÇİN	
WLAN AYARI	
OK GİRİŞ	⌵

4.3 Menü yapısında gezinmek için

Aşağı ve yukarı kaydırmak için "▼", "▲" kullanın.

5 TEMEL KULLANIM

5.1 Ekran Kilidini Açma

Simge  ekrandaysa, kumanda kilitlenebilir. Aşağıdaki sayfa görüntülenir:

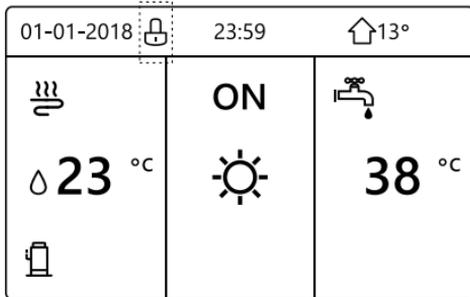

Herhangi bir düğmeye bastığınızda simge  yanıp sönecektir. "UNLOCK" düğmesine uzun basın. Simge  kaybolacaktır, arayüz kontrol edilebilir.

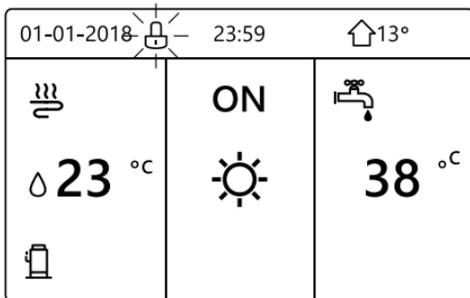

Uzun süre boyunca işlem gerçekleşmezse arayüz kilitlenecektir (yaklaşık 120 saniye) Arayüzün kilidi açılırsa, "UNLOCK" öğesine uzun basın, arayüz kilitlenecektir.

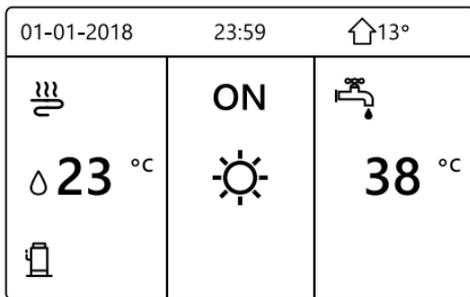

Uzun basın
UNLOCK



Uzun basın
UNLOCK

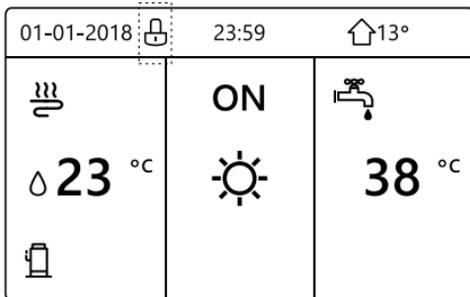

5.2 Kontrolleri AÇIK/KAPALI konuma getirme

Alan ısıtma veya soğutması için üniteyi açmak ya da kapamak üzere arayüzü kullanın.

- Ünitenin AÇIK/KAPALI işlevi, ODA TERMOSTATININ YOK olması durumunda arayüz tarafından kontrol edilebilir. (Bkz. “Kurulum ve kullanıcı kılavuzu (M-termal bölme iç mekan ünitesi)” içindeki “ODA TERMOSTATI AYARI”)
- Ana sayfada “◀”, “▲” simgesine basın, siyah imleç görüntülenir:

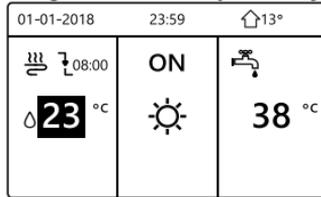

1) İmleç, alan çalışma modu sıcaklığı tarafındaysa (ısıtma modu ❄️, soğutma modu ☀️ ve otomatik mod ⌚ dahil), alan ısıtma veya soğutmasını açmak/kapamak için “ON/OFF” tuşuna basın.

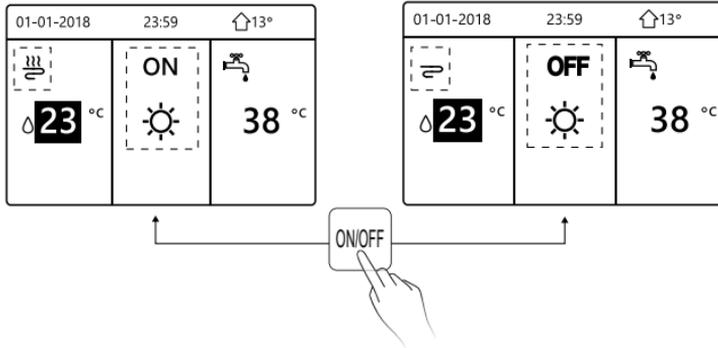

ESS TÜRÜ, YOK olarak ayarlandıysa, aşağıdaki sayılar görüntülenir:

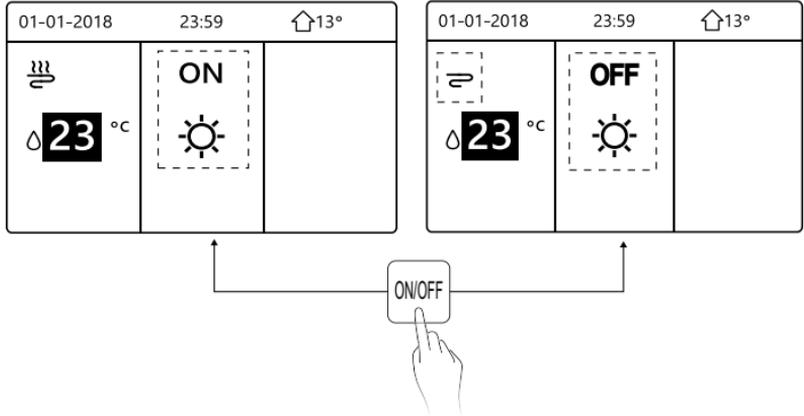

SIC. TÜRÜ, ODA SIC. olarak ayarlandıysa, aşağıdaki sayılar görüntülenir:

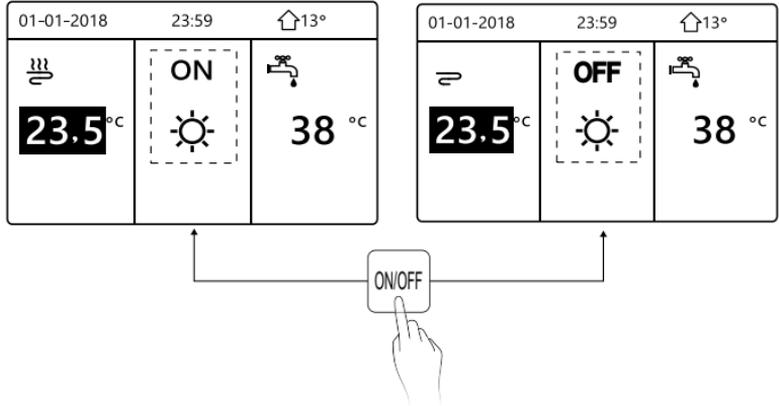

Alan ısıtma veya soğutması için üniteyi açmak ya da kapamak üzere oda termostatını kullanın.

① Oda termostati YOK olarak AYARLANMADIYSA (bkz. “Kurulum ve kullanıcı kılavuzu (M-termal bölme iç mekan ünitesi)” içindeki “ODA TERMOSTATI AYARI”). Alan ısıtma veya soğutması ünitesi, oda termostati tarafından açılır veya kapatılır, Arayüzde ON/OFF düğmelerine basın, aşağıdaki sayfa görüntülenir:

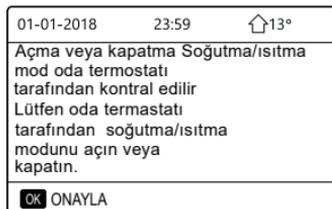

② Oda termostati, ÇİFT BÖLGE olarak AYARLANMIŞ (bkz.

“Kurulum ve kullanıcı kılavuzu (M-termal bölme iç mekan ünitesi)” içindeki “ODA TERMOSTATI AYARI”). Fanlı ısıtıcı için oda termostati kapalı, zemin ısıtması için oda termostati açık ve ünite çalışıyor ancak ekran OFF. Aşağıdaki sayfa görüntülenir:

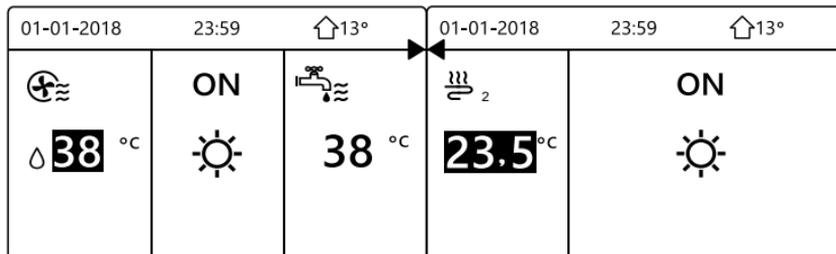

01-01-2018		23:59		🏠13°		01-01-2018		23:59		🏠13°	
⊕		OFF		🔧		↩️ 2		OFF			
Δ 38 °C		☀️		38 °C		23.5 °C		☀️			

ESS için üniteyi açmak ya da kapamak üzere arayüzü kullanın. Ana sayfada “◀”, “▲” simgesine basın, siyah imleç görüntülenir:

01-01-2018		23:59		🏠13°	
☁️		ON		🔧	
Δ 23 °C		☀️		38 °C	

2) İmleç ESS modunun sıcaklığı üzerindeyken, ESS modunu açmak/kapamak için ON/OFF düğmesine basın.

Alan çalışma modu AÇIK ise, Aşağıdaki sayfa görüntülenir:

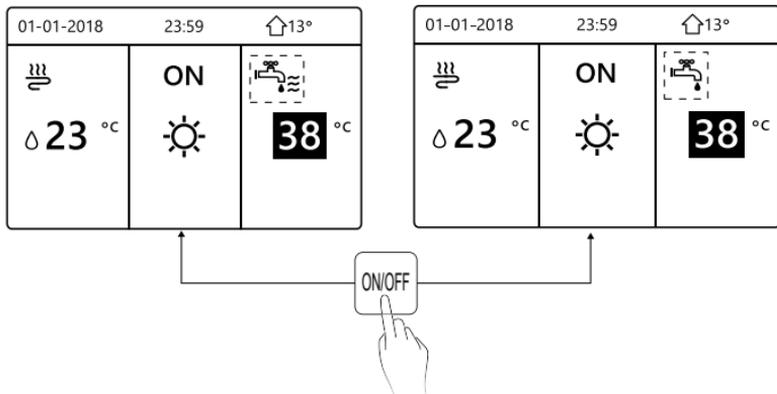

Alan çalışma modu KAPALI ise, Aşağıdaki sayfa görüntülenir:

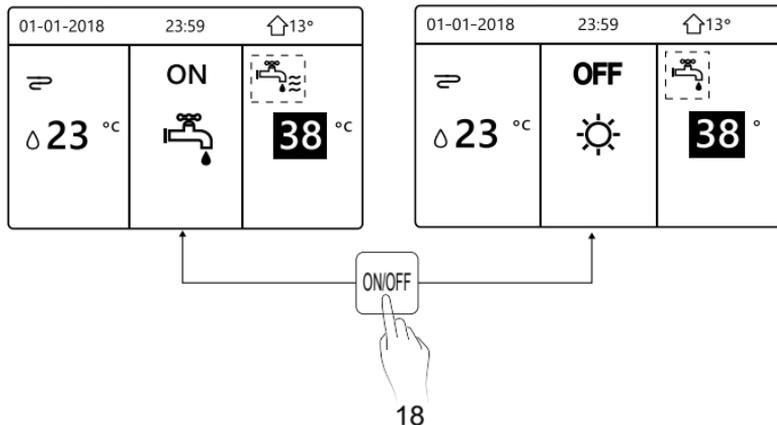

5.3 Sıcaklığı ayarlama

Ana sayfada “◀”, “▲” simgesine basın, siyah imleç görüntülenir:

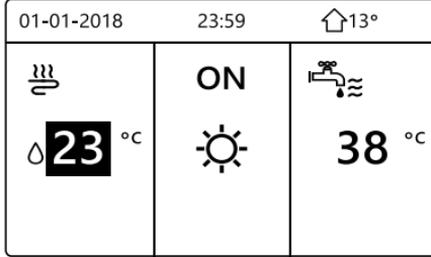

- İmleç sıcaklığın üzerindeyse, seçmek için “◀”, “▶” düğmesine basın. Sıcaklığı ayarlamak için “▲” ve “▼” kullanın.

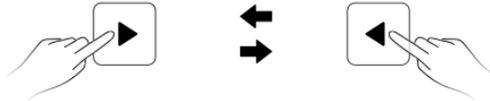
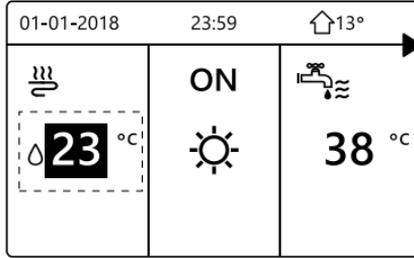

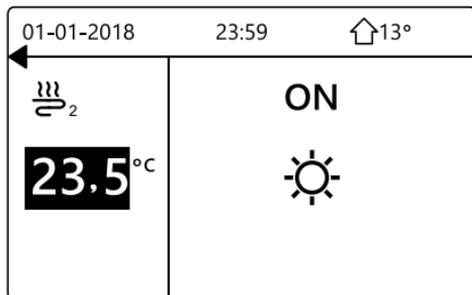
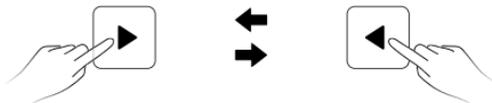
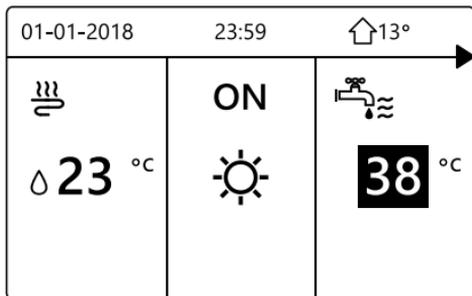

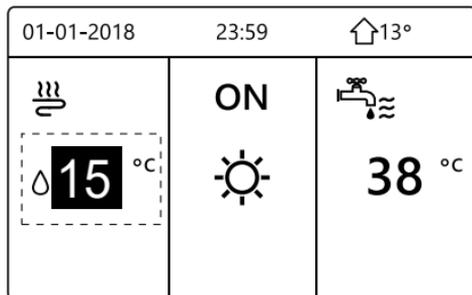
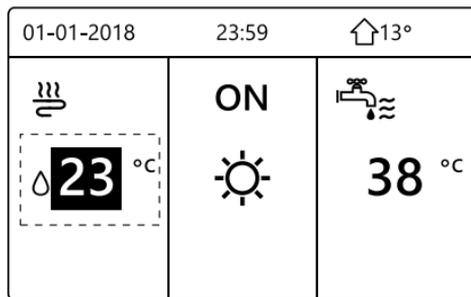

5.4 Alan çalışma modunu ayarlama

- Arayüz aracılığıyla alan çalışma modunu ayarlama“MENÜ” > “ÇALIŞMA MODU” bölümüne gidin. “OK” öğesine basın, aşağıdaki sayfa görüntülenir:

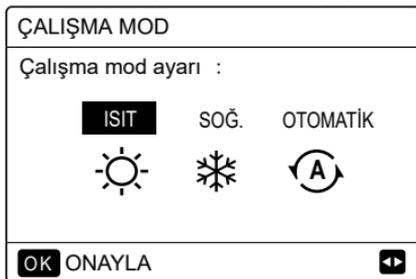

- ISITMA, SOĞUTMA ve OTOMATİK modu içeren seçilecek üç mod vardır. Kaydırmak için “◀”, “▶” kullanın, seçmek için “OK” düğmesine basın.OK düğmesine basmamanız ve GERİ düğmesine basarak sayfadan çıkmanız halinde dahi, imle çalışma moduna getirildiyse mod hala etkin olur.

Yalnızca ISITMA (SOĞUTMA) modu varsa, aşağıdaki sayfa görüntülenir:

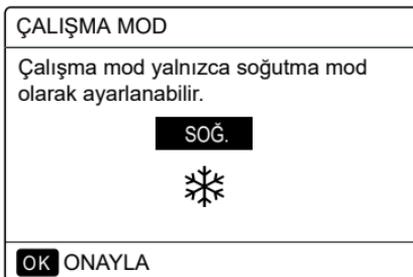
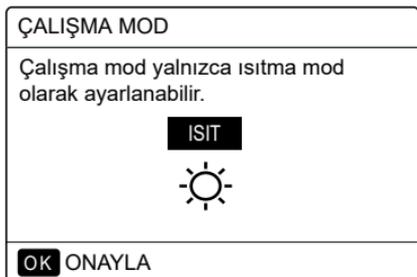

- Çalışma modu değiştirilemez.

Eğer seçerseniz...	Ardından alan çalışma modu...
 ISITMA	Her zaman ısıtma modu
 SOĞUTMA	Her zaman soğutma modu
 OTOMATİK	Dış mekan sıcaklığına dayalı olarak (ve iç mekan sıcaklığının kurucu ayarlarına bağlı olarak) yazılım tarafından otomatik olarak değiştirildi ve aylık kısıtlamaları dikkate alır. Not: Otomatik aktarım yalnızca belirli koşullar altında mümkündür. Bkz. "Kurulum ve kullanıcı kılavuzu (M-termal bölme iç mekan ünitesi)" içindeki "SERVİS ÇALIŞANI İÇİN" > "OTOMATİK MOD AYARI".

- Alan alıřma modunu oda termostati aracılıęıyla ayarlayın, bkz. “Kurulum ve kullanıcı kılavuzu (M-termal bölme iç mekan ünitesi)” içindeki “ODA TERMOSTATI AYARI”.
“MENÜ” > “ALIřMA MODU” kısmına gidin, seçmek veya ayarlamak için herhangi bir düęmeye basarsanız bu sayfa görüntülenir:

01-01-2018	23:59	↑13°
Soęutma/ısıtma mod oda termostati tarafından kontrol edilir.		
Lütfen oda termostatından alıřma modunu ayarlayın.		
OK ONAYLA		

6 Ağ Yapılandırma Kuralları

- Kablolu kumanda, uygulamadan kontrol sinyali alan yerleşik modül ile akıllı kontrolü tanır.
- WLAN'a bağlanmadan önce lütfen ortamınızdaki router'ın aktif olup olmadığını kontrol edin ve kablolu kumandanın kablosuz sinyale uygun biçimde bağlı olduğundan emin olun.
- Kablosuz dağıtım işlemi sırasında "  " LCD simgesi yanıp sönerek ağın kullanılmakta olduğunu gösterir. İşlem tamamlandıktan sonra, "  " simgesi sürekli yanık kalır.

6.1 Kablolu Kumanda Ayarı

Kablolu kumanda ayarları, AP MODU ve WLAN AYARINI GERİ YÜKLE seçeneklerini içerir.

WLAN AYARI
AP MODE
WLAN AYARINI GERİ
OK GİRİŞ 

- WLAN'ı arabirimle etkinleřtirin. "MENÜ" > "WLAN AYARI" > "AP MODU" bölümüne gidin.
"OK"e basın, ařağıdaki sayfa görüntülenir:

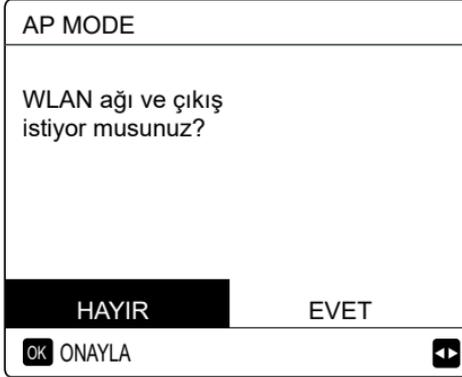

"EVET"e gitmek için "<", ">" kullanın, AP modunu seçmek için "OK"e basın. Karşılık olarak mobil cihazda AP Modunu seçin ve uygulama komutlarına göre ayarları izlemeye devam edin.

DİKKAT

AP moduna girdikten sonra, cep telefonu ile bağlantılı değilse "📶" LCD simgesi 10 saniye yanıp söner ve sonra kaybolur.

Cep telefonu ile bağlantılı ise "📶" simgesi sürekli yanar.

- WLAN ayarını arabirimde geri yükleyin. "MENÜ" > "WLAN AYARI" > "WLAN AYARINI GERİ YÜKLE" bölümüne gidin. "OK"e basın, aşağıdaki sayfa görüntülenir:

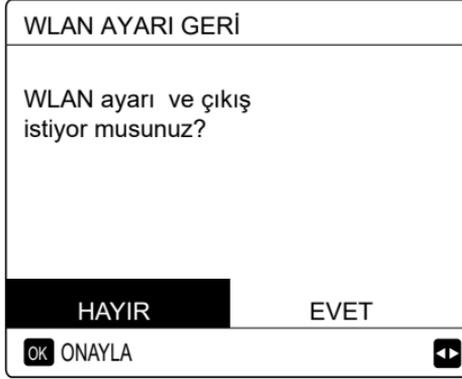

"EVET"e gitmek için "◀", "▶" kullanın, WLAN ayarını geri yüklemek için "OK"e basın. Yukarıdaki işlemi tamamlayın ve kablosuz yapılandırma sıfırlanır.

6.2 Mobil Cihaz Ayarı

AP Modu, mobil cihaz tarafında kablosuz dağıtım için kullanılabilir.

- AP Modu WLAN bağlantısı:

6.2.1 Uygulamayı yükleme

- ① Smart Home Uygulamasını yüklemek için aşağıdaki kare kodunu taratın.



- ② Uygulamayı yüklemek için APP STORE'da veya GOOGLE PLAY'de "MSmartLife" araması için basın.

Bu APP yalnızca Android 7.0 ve IOS7 veya daha yeni işletim sistemleri için geçerlidir.

6.2.2 Oturum açma/Kaydolma

Lütfen kayıt kodunuzu girin. Veya varsa denetleyici ambalaj kutusundaki QR kodunu tarayın. Hesabınızı rehberle göre kaydedin.

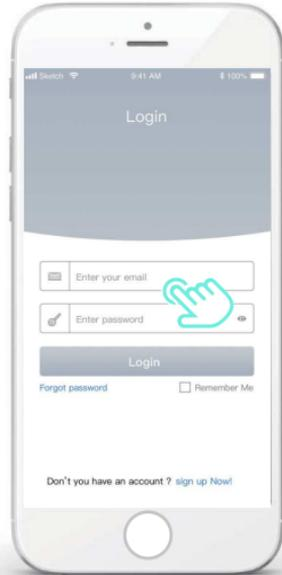
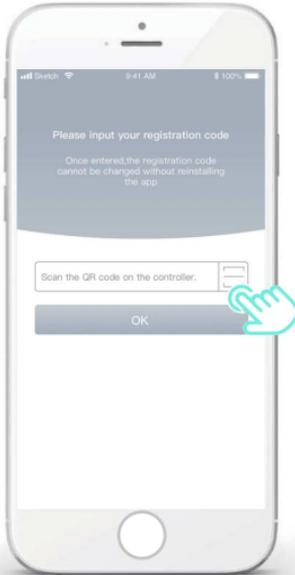

6.2.3 Ev Cihazlarını Ekleme:

1) Talimatları izleyerek cihazınızı ekleyin.

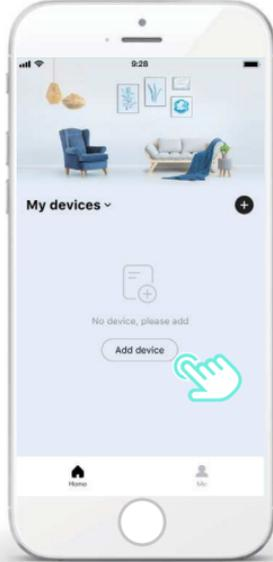

2) Kablolu kumandayı uygulama komutlarına göre çalıştırın.



3) Ev cihazlarının bağlanmasını bekleyin, ardından "Complete"e tıklayın.

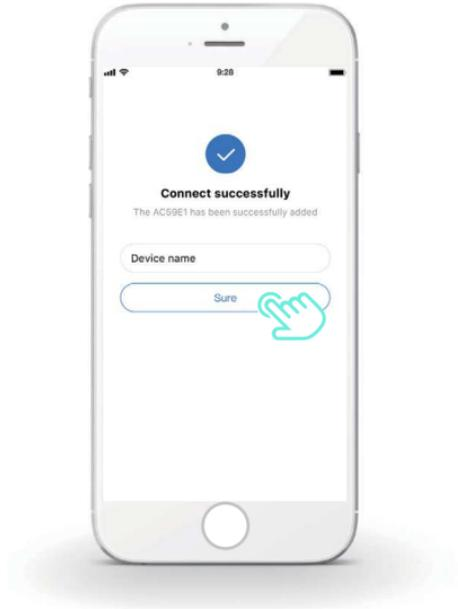

- 4) Cihaz başarıyla bağlandıktan sonra kablolu kumandanın "📶" LCD simgesi sürekli yanar ve klima, uygulama üzerinden kontrol edilebilir.
- 5) Ağ dağıtım işlemi başarısız olursa veya mobil bağlantı, yeniden bağlanma veya değiştirme isteğinde bulunursa, kablolu kumanda "WiFi Fabrika Ayarlarına Sıfırlama" işlemini çalıştırın ve ardından yukarıdaki işlemi yineleyin.

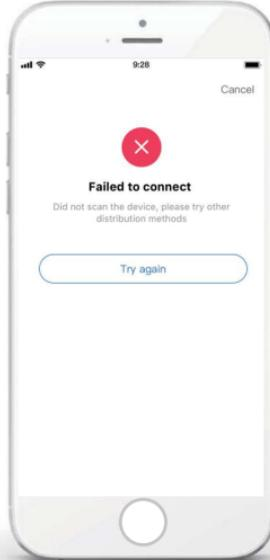



Ağ arızaları için uyarılar ve sorun giderme

Ürün ağı yeniden bağlandığında, lütfen telefonun ürüne mümkün olduğunca yakın bir yerde durduğundan emin olun.

Şu anda yalnızca 2,4GHz bandındaki router'ları destekliyoruz.

WLAN adında özel karakterler (noktalama, boşluklar vb.) bulunması önerilmez.

Ev cihazlarının zayıf veya kararsız ağ sinyalinden etkilenmemesi için tek bir router'a 10'dan fazla cihaz bağlamamanız önerilir.

Router ya da Wi-Fi parolası değişirse, tüm ayarları temizleyin ve cihazı sıfırlayın.

Uygulamanın içeriği, sürüm güncellemelerinde değişebilir ve asıl işlem geçerli olur.

7 KURULUM KILAVUZU

7.1 Güvenlik önlemleri

- Üniteyi kurmadan önce güvenlik önlemlerini dikkatlice okuyun.
- Aşağıda belirtilenler, riayet edilmesi gereken önemli güvenlik konularıdır.
- Tamamlandıktan sonra test işlemi sırasında anormal bir olay olmadığını onaylayın ve ardından, kılavuzu kullanıcıya verin.
- İşaretlerin anlamı:



DİKKAT

Yanlış bir hareketin kişinin ölümüne veya ağır yaralanmasına yol açabileceği anlamına gelir.



DİKKAT

Yanlış bir hareketin kişinin yaralanmasına veya mal kaybına yol açabileceği anlamına gelir.

DİKKAT

Kurulması için üniteyi lütfen distribütöre veya uzmanlara emanet edin. Başka kişiler tarafından yapılan kurulumlar, hatalı kurulum, elektrik çarpmasına veya yangına yol açabilir.

Bu kılavuza tamamıyla uyun.

Yanlış kurulum, elektrik çarpmasına veya yangına yol açabilir.

Yeniden kurulum, uzmanlar tarafından gerçekleştirilmelidir.

Yanlış kurulum, elektrik çarpmasına veya yangına yol açabilir.

Klimanızı istediğiniz zaman sökmeyin.

Rastgele bir sökme işlemi, yangına yol açabilecek anormal çalışmaya veya ısınmaya neden olabilir.

DİKKAT

Üniteyi, yanıcı gaz kaçağına maruz kalabileceği bir yere kurmayın.

Yanıcı gaz kaçağının olması ve bu gazların kablolu kumandanın çevresinde kalması halinde yangın çıkabilir.

Kablolama, kablolu kumanda akımına uygun olmalıdır.

Aksi halde, elektrik kaçağı veya ısınma meydana gelebilir ve yangın çıkabilir.

Kablolamaya belirtilen teller uygulanmalıdır. Terminale harici kuvvet uygulanamaz.

Aksi halde, kablo kopması ve ısınması meydana gelebilir ve yangın çıkabilir.

Kumandanın uzaktan sinyallerinin kesintiye uğramaması için, kablolu uzaktan kumandayı lambaların yakınına koymayın. (sağdaki şekle bakın)



7.2 Diğer Önlemler

7.2.1. Kurulum yeri

Üniteyi fazla yağlı, buharlı, sülfat gazlı bir yere kurmayın.
Aksi halde, ürün deforme olup arızalanabilir.

7.2.2 Kurulum öncesi hazırlık

1) Aşağıdaki montaj elemanlarının eksiksiz olup olmadığını kontrol edin.

No.	Adı	Adet	Notlar
1	Kablolu Kumanda	1	_____
2	Çapraz yuvarlak başlı ahşap montaj vidası	3	Duvara Montaj İçin
3	Çapraz yuvarlak başlı montaj vidası	2	Elektrik Dağıtım Kutusuna Montaj İçin
4	Kurulum ve Kullanıcı Kılavuzu	1	_____
5	Plastik cıvata	2	Bu aksesuar, merkezi kumanda, elektrik panosunun içine takıldığında kullanılır.
6	Plastik genişleme borusu	3	Duvara montaj için

7.2.3 Kablolu kumandanın takılmasıyla ilgili not:

- 1) Bu kurulum kılavuzu, Kablolu Uzaktan Kumandanın kurulum prosedürü hakkında bilgiler içerir. Kablolu Uzaktan Kumanda ve İç Mekan Ünitesi arasındaki bağlantı için, lütfen İç Mekan Ünitesi Kurulum Kılavuzuna başvurun.
- 2) Kablolu Uzaktan Kumandanın devresi, düşük gerilimli devredir. Bunu asla standart bir 220 V / 380 V devreyle bağlamayın veya devreyle aynı Kablo Kanalı içerisine koymayın.
- 3) Blendajlı kablo, toprağa stabil şekilde bağlanmalıdır; aksi halde aktarım başarısız olabilir.
- 4) Blendajlı kabloyu keserek uzatmaya çalışmayın; gerekirse bağlamak için Terminal Bağlantısı Bloğu kullanın.
- 5) Bağlantıyı tamamladıktan sonra sinyal kablosunda yalıtım kontrolü için Megger'i kullanın.

7.3 Kurulum prosedürü ve kablolu kumandayla uyumlu ayar

7.3.1 Yapı boyut şekli

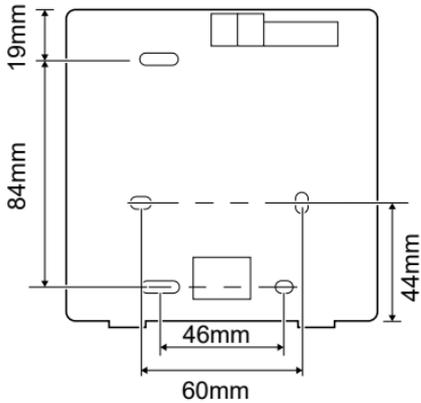
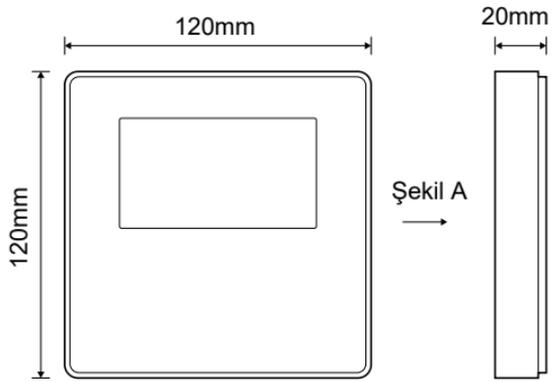

7.3.2 Kablolama

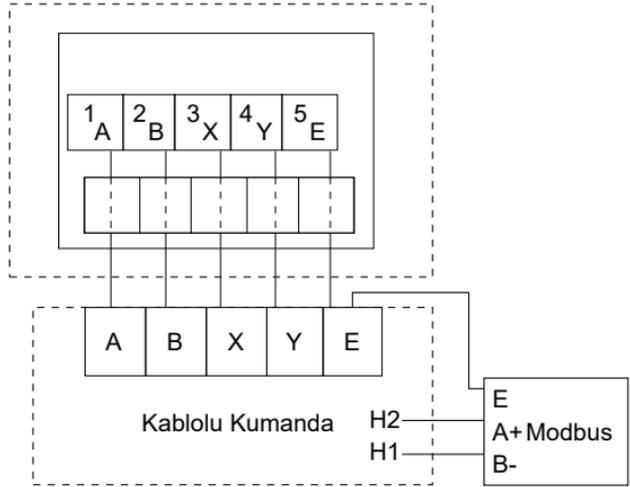

Giriş Gerilimi (A/B)	13,5 VAC
Kablo boyutu	0,75 mm ²

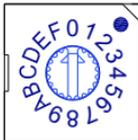

Hidrolik modülün ana kumanda panelindeki dönen kodlu anahtar S3 (0-F), modbus adresinin ayarlanması için kullanılır.

Varsayılan olarak ünitelerde bu kodlu anahtar 0'a konumlandırılmıştır; ancak bu konum, modbus adresi 16'ya karşılık gelirken diğerlerinin konumları, ilgili numaralara karşılık gelir; ör. konum 2 için adres 2'dir, konum 5 için adres 5'tir.

7.3.3 Arka kapağın takılması

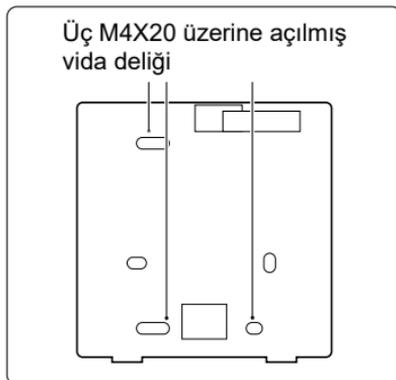
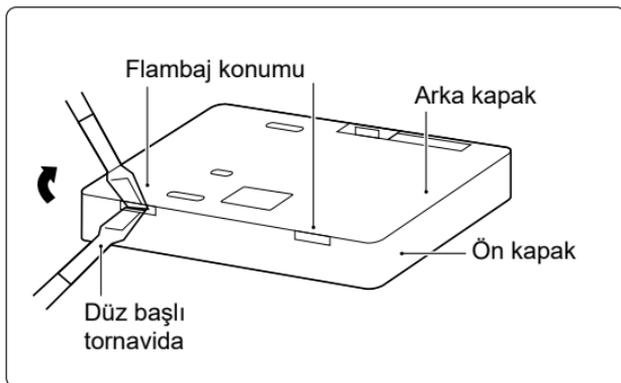

Üç M4X20 üzerine açılmış
vida deliği

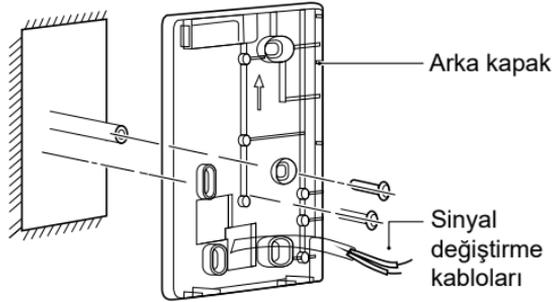

- 1) Flambaj konumunu kablolu kumandanın altına doğru takmak için düz başlı tornavida kullanın ve arka kapağı sökmek için tornavidayı döndürün. (Döndürme yönüne dikkat edin; aksi halde arka kapak zarar görebilir!)
- 2) Arka kapağı doğrudan duvara takmak için üç adet M4X20 vida kullanın.
- 3) Arka kapağı 86 elektrik kutusuna takmak için, iki adet M4X25 vida kullanın ve duvara sabitlemek için de bir M4X20 vida kullanın.
- 4) Aksesuar içindeki iki plastik vidalı çubuğun uzunluğunu, elektrik kutusu vidalı çubuğundan duvara standart uzunlukta olacak şekilde ayarlayın. Vidalı çubuğu duvara takarken duvar kadar düz olduğundan emin olun.
- 5) Kablolu kumandanın alt kapağını duvardaki vidalı çubuk üzerinden sabitlemek için çapraz başlı vidalar kullanın. Kablolu kumandanın alt kapağının kurulumdan sonra aynı seviyede olduğundan emin olun ve ardından, kablolu kumandayı tekrar alt kapağa takın.
- 6) Vidayı aşırı sıkarak, arka kapağın deforme olmasına yol açar.

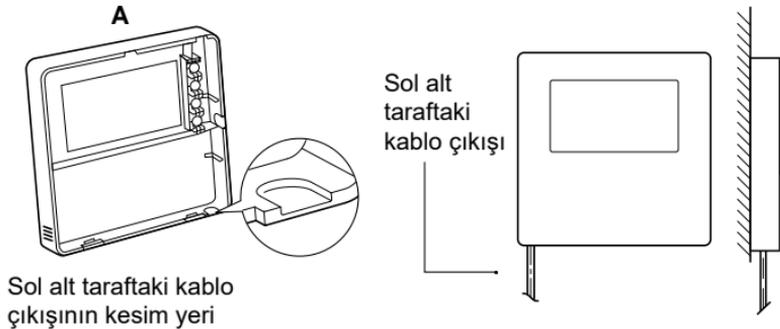

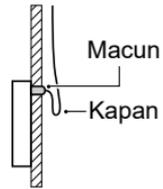
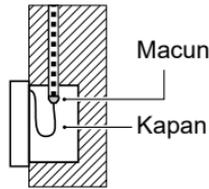
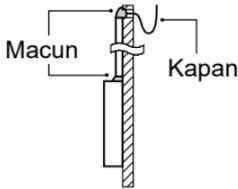
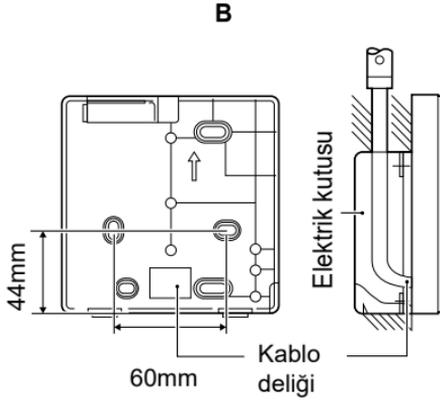

Kablolu uzaktan kumandaya su girmesini engelleyin; kablo tesisatı kurulumu sırasında kablo bağlantı elemanlarının sızdırmazlığını sağlamak için macun ve kapan kullanın.

7.4 Ön kapağın takılması

Ön kapağı ayarladıktan sonra tokalarından takın; takma sırasında iletişim alışverişisi kablosunu sıkıştırmaktan kaçının.

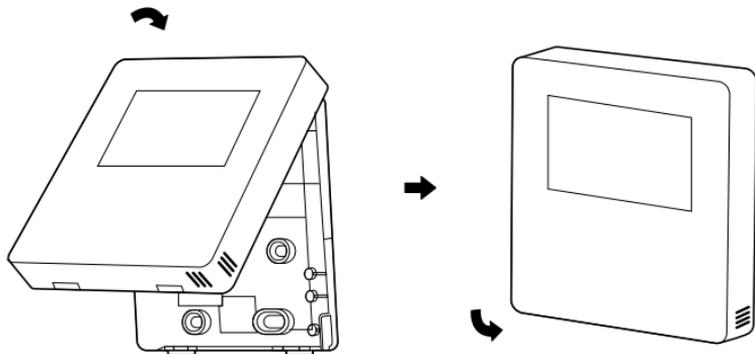

Sensör, nemden etkilenebilir.

Arka kapađı dođru Őekilde takın ve 6n kapađı ve arka kapađı sıkıca tokala-
rından takın; aksi halde 6n kapak d6Őer.

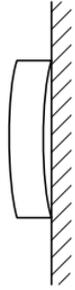

- Deze handleiding geeft een gedetailleerde beschrijving van de voorzorgsmaatregelen waar u tijdens gebruik op moet letten.
- Lees deze handleiding aandachtig door voordat u het apparaat gebruikt om een juiste werking van de bedrade controller te garanderen.
- Deze handleiding bewaren om later te kunnen raadplegen.

INHOUD

1 ALGEMENE VEILIGHEIDSMATREGELEN

- 1.1 Over de documentatie 1
- 1.2 Voor de gebruiker 2

2 EEN BLIK OP DE GEBRUIKERSINTERFACE

- 2.1 Beschrijving van bedrade controller 5
- 2.2 Statuspictogrammen 6

3 STARTPAGINA'S GEBRUIKEN

- 3.1 Over startpagina's 7

4 MENUSTRUCTUUR

- 4.1 Over de menustructuur..... 11
- 4.2 Menustructuur openen 11
- 4.3 Navigeren in menustructuur..... 11

5 BASISGEBRUIK

- 5.1 Scherm ontgrendelen..... 12
- 5.2 AAN/UIT-bedieningselementen..... 14
- 5.3 Temperatuur aanpassen 19
- 5.4 Bedrijfsmodus van ruimte aanpassen 22

6 Richtlijnen voor netwerkconfiguratie

- 6.1 Instelling bedrade controller..... 25
- 6.2 Instellingen mobiel apparaat..... 28

7 INSTALLATIEHANDLEIDING

- 7.1 Veiligheidsmaatregel..... 35
- 7.2 Overige voorzorgsmaatregelen 38
- 7.3 Installatieprocedure en bijpassende instelling
van bedrade controller 39
- 7.4 Installatie voorwand 46

1 ALGEMENE VEILIGHEIDSMaatregelen

1.1 Over de documentatie

- De originele documentatie is in het Engels geschreven. Alle andere talen zijn vertalingen.
- De voorzorgsmaatregelen die worden beschreven in dit document hebben betrekking op zeer belangrijke onderwerpen.
- Alle activiteiten beschreven in de installatiehandleiding moeten worden uitgevoerd door een geautoriseerde installateur.

1.1.1 Betekenis van waarschuwingen en symbolen

GEVAAR

Duidt op een situatie die fataal of ernstig letsel tot gevolg kan hebben.

GEVAAR:GEVAAR VAN LEKTROCIJTIE

Duidt op een situatie die kan leiden tot schokgevaar.

GEVAAR:GEVAAR OP RANDWONDEN

Duidt op situatie die kan resulteren in brandwonden door extreem hoge of lage temperaturen.



WAARSCHUWING

Duidt op een situatie die kan leiden tot fatale ongelukken of ernstig letsel.



OPGELET

Duidt op een situatie die kan leiden tot licht of matig letsel.
.....



OPMERKING

Duidt op een situatie die kan leiden tot schade aan apparatuur of eigendom.
.....



INFORMATIE

Duidt op nuttige tips of aanvullende informatie.

1.2 Voor de gebruiker

- Neem contact op met uw installateur als u niet zeker weet hoe u het apparaat moet bedienen.

- Het apparaat is niet bedoeld voor gebruik door personen, inclusief kinderen, met verminderde fysieke, sensorische of mentale vermogens, of mensen met gebrek aan ervaring en kennis, tenzij onder toezicht of op basis van instructies door een persoon die verantwoordelijk is voor hun veiligheid. Kinderen mogen niet met het apparaat spelen.



OPGELET

Spoel het apparaat NIET af. Dit kan elektrische schokken of brand veroorzaken.



OPMERKING

- Plaats GEEN voorwerpen of apparatuur op het apparaat.
- Ga NIET op het apparaat zitten, klimmen of staan.

- Het apparaat is gemarkeerd met het volgende symbool:



Elektrische en elektronische producten kunnen niet worden gecombineerd met ongesorteerd huishoudelijk afval. Probeer het systeem NIET zelf te demonteren: het demonteren van het systeem, de verwerking van het koelmiddel, olie en of onderdelen moet worden uitgevoerd door een geautoriseerde installateur en moeten voldoen aan de toepasselijke wetgeving. Apparaten moeten worden verwerkt in een gespecialiseerde verwerkingsfaciliteit voor hergebruik, recycling en terugwinning. Door ervoor te zorgen dat dit product op de juiste manier wordt verwijderd, helpt u mogelijke schade voor het milieu en de menselijke gezondheid te voorkomen. Neem voor meer informatie contact op met uw installateur of plaatselijke overheid.

2 EEN BLIK OP DE GEBRUIKERSINTERFACE

2.1 Beschrijving van bedrade controller

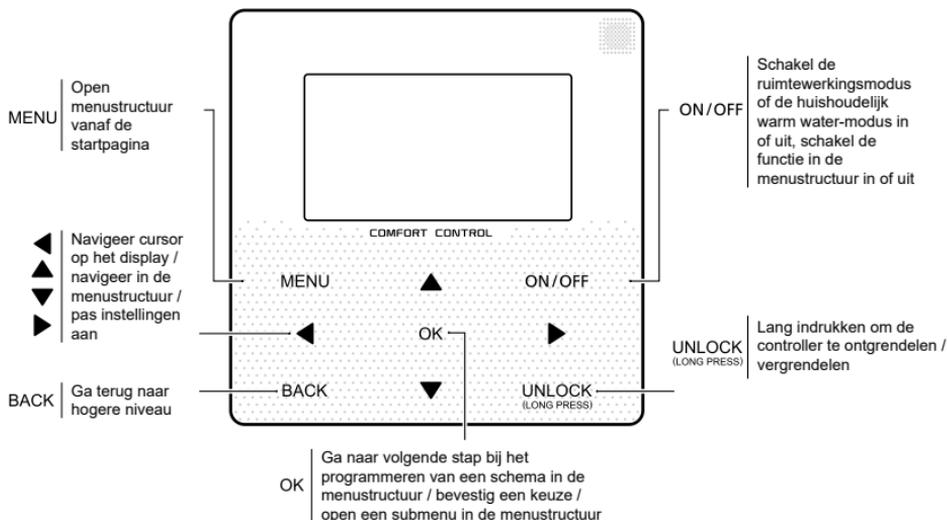

2.2 Statuspictogrammen

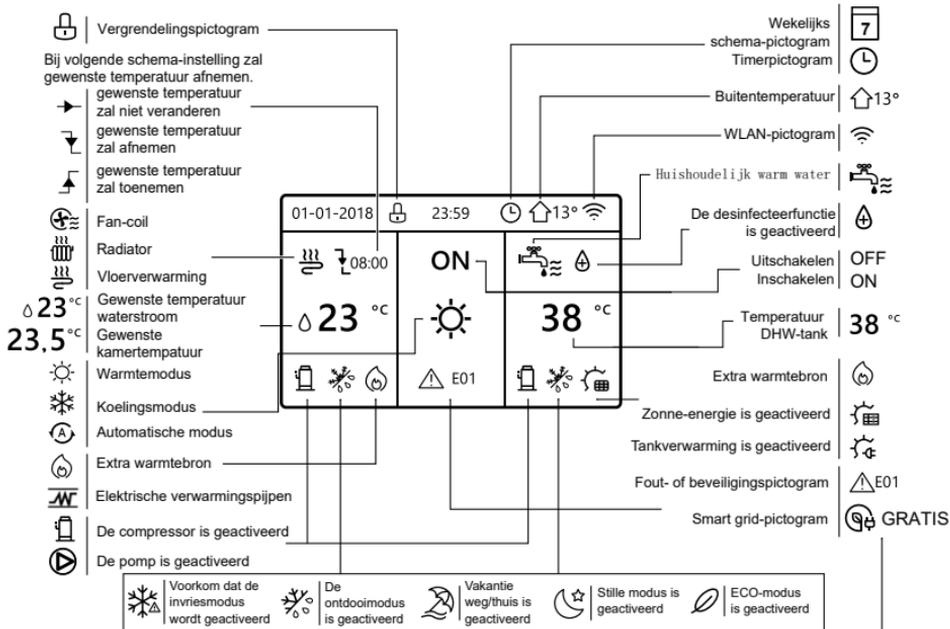

	Fan-coil	Radiator	Vloerverwarming	Huishoudelijk warm water
ON (AAN)				
OFF (UIT)				

	Gratis elektriciteit	Dal-elektriciteit	Piek-elektriciteit
Smart grid	GRATIS	DAL	PIEK

3 GEBRUIK VAN STARTPAGINA'S

3.1 Over startpagina's

Gebruik de startpagina's om instellingen uit te lezen en te wijzigen die bedoeld zijn voor dagelijks gebruik. Wat u op de startpagina's kunt zien en doen, wordt beschreven waar relevant. Afhankelijk van de systeem lay-out zijn de volgende startpagina's beschikbaar:

- Gewenste kamertemperatuur (KAMER)
- Gewenste temperatuur waterstroom (MAIN)
- Werkelijke temperatuur van DHW-tank (TANK)

DHW = huishoudelijk warm water

startpagina 1 :

Als WATERSTROOMTEMP. is ingesteld op JA en KAMERTEMP. is ingesteld NEE. Het systeem heeft de functie inclusief vloerverwarming en huishoudelijk warm water, startpagina 1 verschijnt:

OPMERKING

Alle afbeeldingen in de handleiding zijn ter referentie. De werkelijke pagina's op het scherm kunnen iets afwijken.

01-01-2018 			23:59 			↑13°		
 23 °C		ON 		 38 °C				
								

startpagina2:

Als de WATERSTROOMTEMP. is ingesteld NEE en RUIJTE TEMP. is ingesteld op JA . Het systeem heeft de functie inclusief vloerverwarming en huishoudelijk warm, de startpagina 2 verschijnt:

OPMERKING

De bedrade controller moet in de vloerverwarmingsruimte worden geïnstalleerd om de kamertemperatuur te controleren.

01-01-2018  23:59   13°		
 23.5 °C 	ON 	 38 °C

startpagina3:

Als de DHW-MODUS is ingesteld op NEE , en als "WATERSTROOMTIMER" is ingesteld op JA, "KAMERTEMP" is ingesteld op JA, Er verschijnt een hoofdpagina en een aanvullende pagina. Het systeem heeft de functie inclusief vloerverwarming en ruimteverwarming voor ventilatorconvector, startpagina 3 verschijnt:

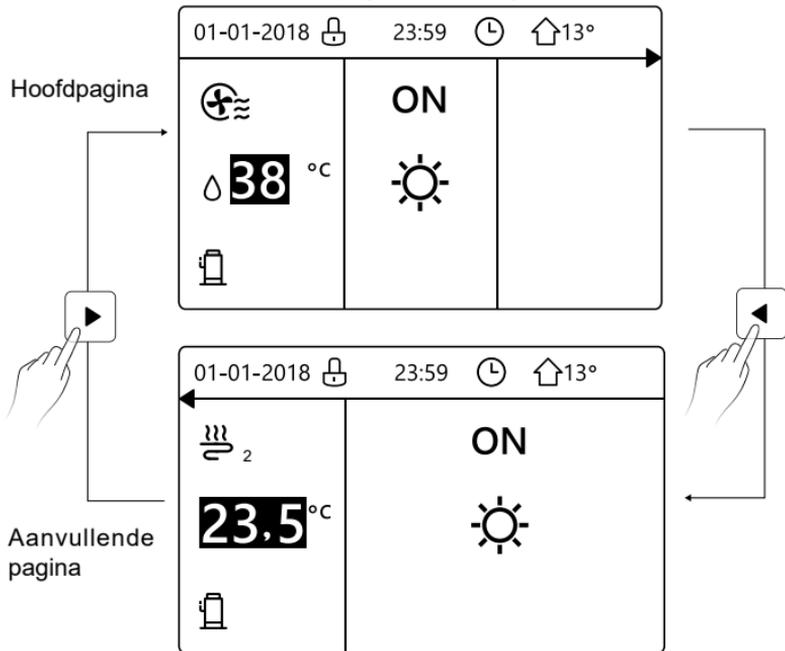

startpagina4 :

Als de KAMERTHERMOSTAAT is ingesteld op DUBBELE ZONE of DOUBLE ZONE op JA ingesteld. Er verschijnt een hoofdpagina en een aanvullende pagina. Het systeem heeft de functie inclusief vloerkoeling, ruimtekoeling voor ventilatorconvector en warm water voor huishoudelijk gebruik, startpagina 4 verschijnt:

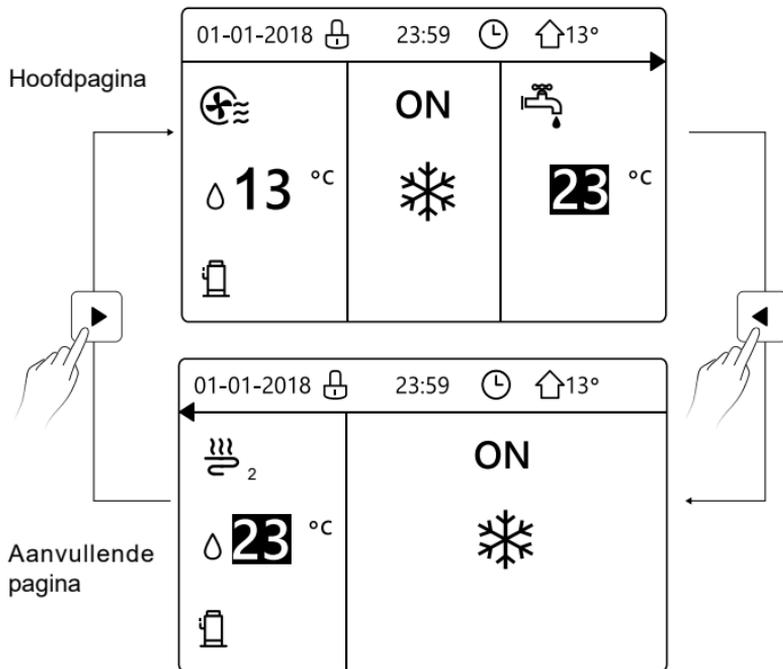

4 MENUSTRUCTUUR

4.1 Over de menustructuur

Gebruik de menustructuur om instellingen te lezen en te wijzigen die NIET bedoeld zijn voor dagelijks gebruik. Wat u kunt zien en doen in de menustructuur wordt beschreven waar van toepassing.

4.2 Menustructuur openen

Druk vanuit een startpagina op "MENU". U ziet vervolgens de menustructuur:

MENU	1/2
BEDRIJFSMODUSMODUS	
PRESET TEMPERATUUR	
WARM WATER	
SCHEMA	
OPTIES	
KINDERSLOT	
OK OPENEN	

MENU	2/2
SERVICE INFORMATIE	
BEDRIJFSPARAMETER	
VOOR ONDERHOUDSMONTEUR	
WLAN INSTELLING	
OK OPENEN	

4.3 Navigeren in menustructuur

Gebruik "▼", "▲" om te bladeren.

5 BASISGEBRUIK

5.1 Scherm ontgrendelen

Als het pictogram  op het scherm staat, is de controller vergrendeld. Het volgende beeld wordt getoond:

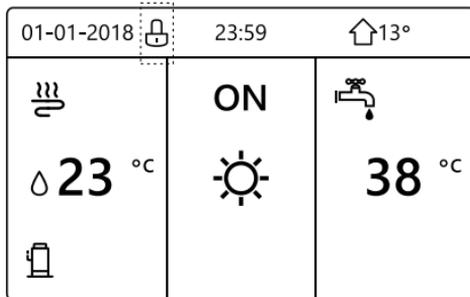

Druk op een willekeurige toets. Het pictogram  gaat knipperen. Druk lang op de "UNLOCK" toets. Het pictogram  verdwijnt, de interface kan worden gebruikt.

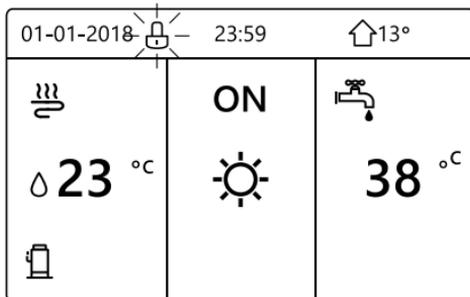

De interface wordt vergrendeld als er enige tijd geen activiteit is (ongeveer 120 seconden) Als de interface is ontgrendeld, drukt u lang op "UNLOCK" en wordt de interface vergrendeld.

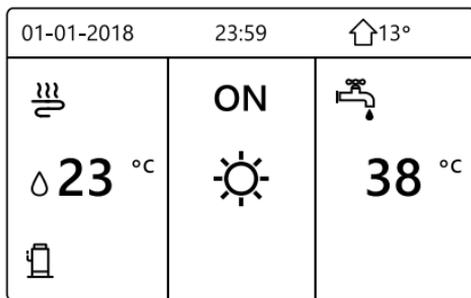

Druk lang op UNLOCK ↓ ↑ Druk lang op UNLOCK

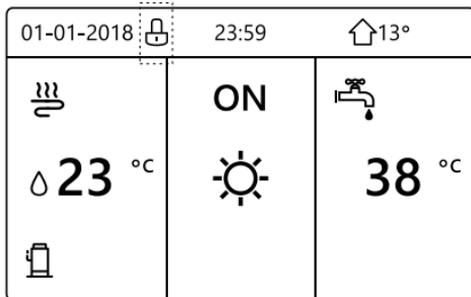

5.2 AAN/UIT-regelaars

Gebruik de interface om de unit in of uit te schakelen voor kamerverwarming of koeling.

- De AAN/UIT functie van het apparaat kan worden bestuurd door de interface als de KAMERTHERMOSTAAT insteld is op NEE. (zie "KAMERTHERMOSTAAT INSTELLING" in "Installatie- en gebruikershandleiding (M-thermische split binnenunit)")
- Druk op "◀", "▲" op de startpagina. De zwarte cursor verschijnt:

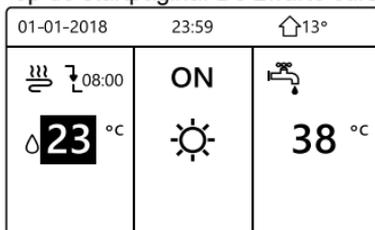

Wanneer de cursor op de temperatuur bij de modus kamerfunctie staat (inclusief verwarmingsmodus ☀, koelmodus ☀ en automatische modus (A)), drukt u op de toets "ON/OFF" om kamerverwarming of -koeling in of uit te schakelen.

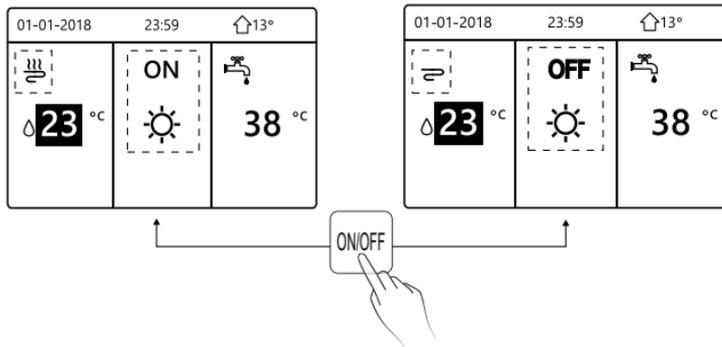

Als het DHW-TYPE op NEE is ingesteld, worden de volgende pagina's getoond:

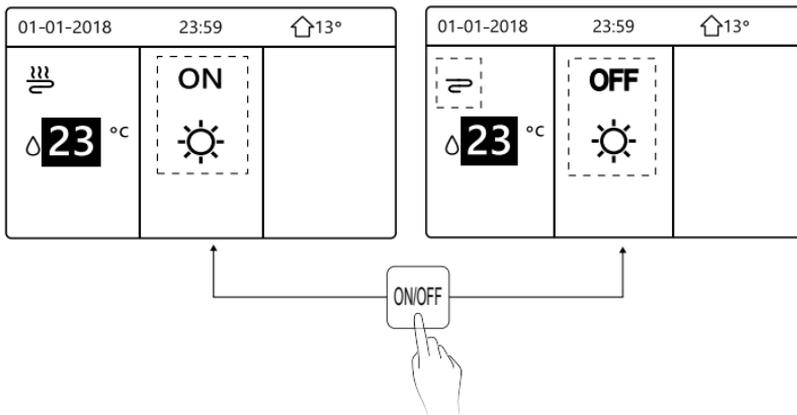

Als TEMP. TYPE is ingesteld KAMERTEMP., verschijnen de volgende pagina's:

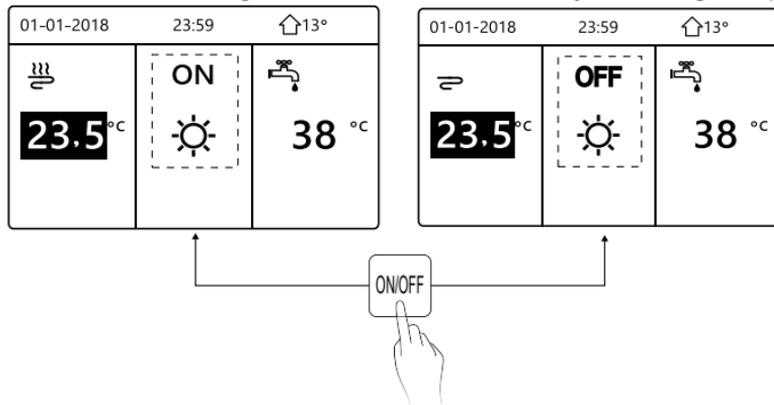

Gebruik de kamerthermostaat om de unit in of uit te schakelen voor verwarming of -koeling van de ruimte.

- ① De kamerthermostaat staat niet op NEE (zie "KAMERTHERMOSTAAT INSTELLING" in "Installatie- en gebruikershandleiding (M-thermische split binneneunit)"). De unit voor verwarming of -koeling wordt in- of uitgeschakeld met de kamerthermostaat, druk op ON/OFF op de interface. De volgende pagina worden getoond:



- ② De kamerthermostaat staat op INSTELLING DUBBELE ZONE (zie "KAMERTHERMOSTAATINSTELLING" in "Installatie- en gebruikershandleiding (M-thermische split binneneunit)"). De kamerthermostaat voor fan-coil is uitgeschakeld, de kamerthermostaat voor vloerverwarming is ingeschakeld en de unit is in bedrijf, maar het display staat OFF. Het volgende beeld wordt getoond:

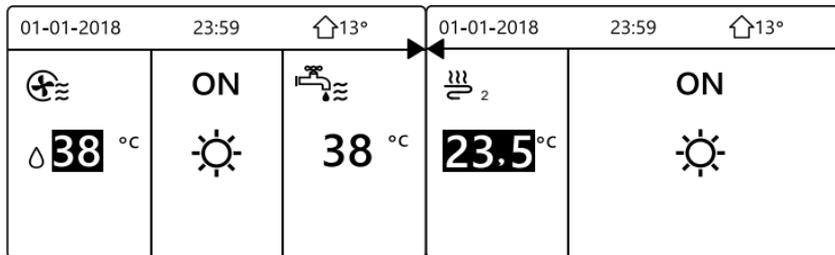

01-01-2018		23:59		🏠 13°		01-01-2018		23:59		🏠 13°	
⊕		OFF		🚰		↩ 2		OFF		☀	
Δ 38 °C		☀		38 °C		23.5 °C		☀			

Gebruik de interface om het apparaat in of uit te schakelen voor DHW. Druk op "▶", "▼" op de startpagina. De zwarte cursor verschijnt:

01-01-2018		23:59		🏠 13°	
☁		ON		🚰	
Δ 23 °C		☀		38 °C	

2) Wanneer de cursor op de temperatuur van de SWW-modus staat. Druk op de "ON/OFF" toets om de DHW-modus in/uit te schakelen.

Als de ruimtemodus AAN is, zullen de volgende pagina's worden getoond:

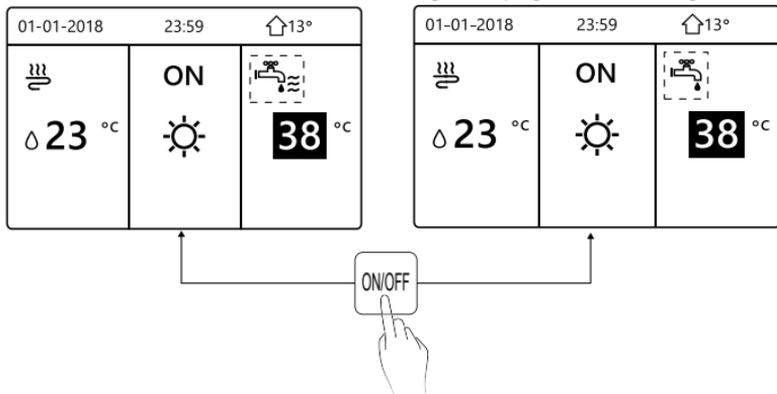

Als de ruimtewerkingsmodus UIT is, zullen de volgende pagina's worden getoond:

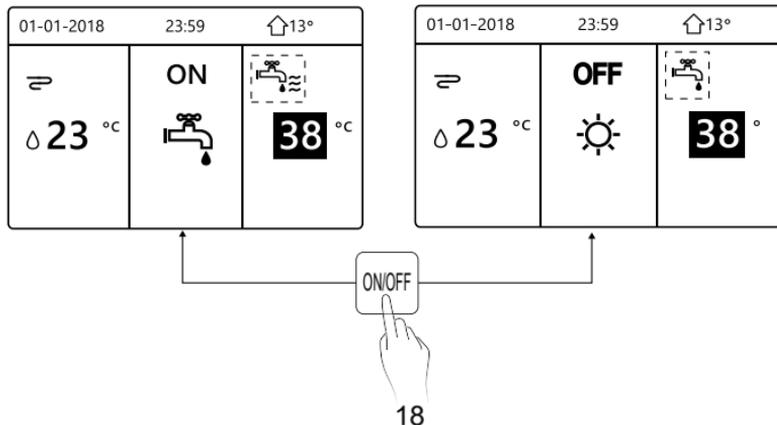

5.3 Temperatuur aanpassen

Druk op "◀", "▲" op de startpagina. De zwarte cursor verschijnt:

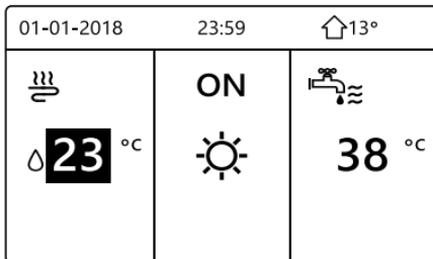

- Als de cursor op de temperatuur staat, gebruik dan de "◀", "▶" om te selecteren en "▼", "▲" om de temperatuur aan te passen.

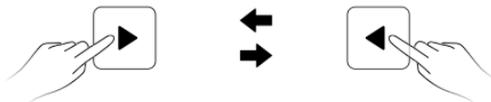
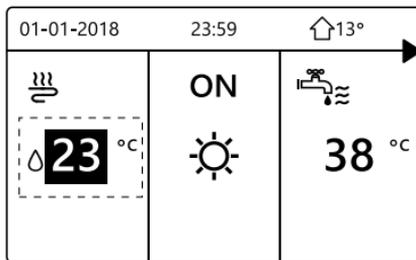

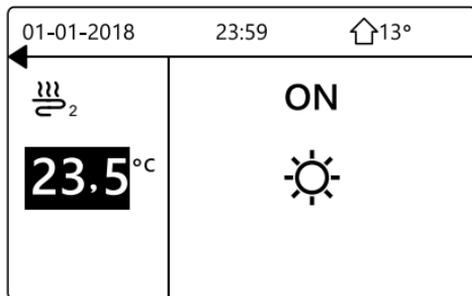
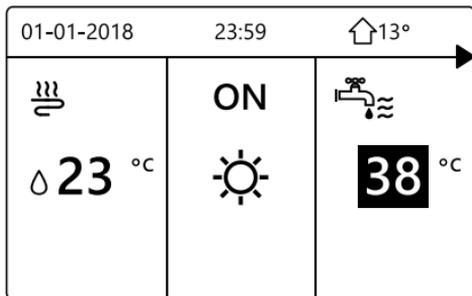

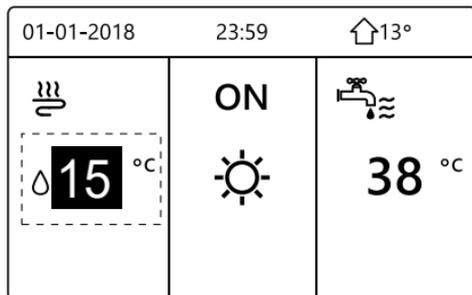
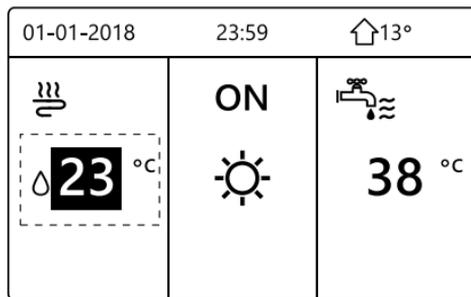

5.4 Bedrijfsmodus van ruimte aanpassen

- De ruimte-bedrijfsmodus aanpassen via interface a naar "MENU" > "BEDRIJFSMODUS". Druk op "OK". De volgende pagina verschijnt:

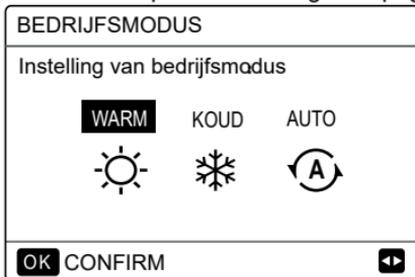

- Er kunnen drie standen worden geselecteerd: WARM, KOEL en AUTO. Gebruik "◀", "▶" om te scrollen en druk op "OK" om te selecteren. Ook als u niet op OK drukt en de pagina verlaat door op de knop TERUG te drukken, blijft de modus werken als de cursor naar de bedrijfsmodus is verplaatst.

Als er alleen de modus VERWARMEN (KOELEN) is, wordt de volgende pagina weergegeven:

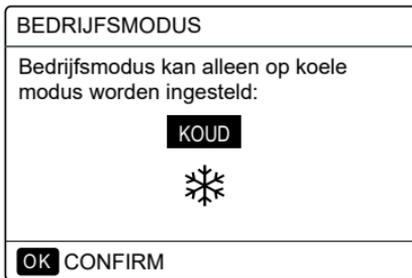
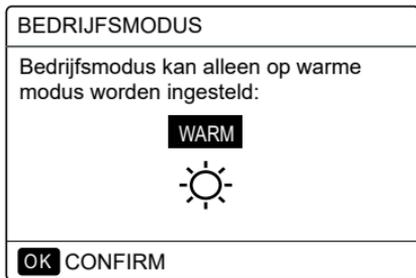

- De bedrijfsmodus kan niet worden gewijzigd.

Als u dit selecteert...	Dan is de kamerfunctie-modus ...
 WARM	Altijd warm-modus
 KOUD	Altijd koel-modus
 AUTO	<p>Automatisch gewijzigd door de software op basis van de buitentemperatuur (en afhankelijk van de instellingen van de installateur van de binnentemperatuur), rekening houdend met maandelijkse beperkingen.</p> <p>Opmerking: Automatische omschakeling is alleen mogelijk onder bepaalde voorwaarden.</p> <p>Zie "VOOR ONDERHOUDSMONTEUR" > "AUTO MODUS INSTELLING" in "Installatie- en gebruikershandleiding (M-thermische split binneneenheid)".</p>

- Stel de kamerfunctie-modus in met de kamerthermostaat (zie "KAMERTHERMOSTAAT INSTELLING" in "Installatie- en gebruikershandleiding (M-thermische split binnenunit)") Ga naar "MENU" > "BEDRIJFSMODUS". Als u op een willekeurige toets drukt om te selecteren of in te stellen, wordt de volgende pagina weergegeven:



6 Richtlijnen voor netwerkconfiguratie

- De bedrade controller regelt intelligente besturing met een ingebouwde module die het besturingssignaal van de APP ontvangt.
- Controleer voordat u het WLAN aansluit of uw router is ingeschakeld en zorg ervoor dat de bedrade controller goed is verbonden met het draadloze signaal.
- Tijdens het draadloze distributieproces knippert het LCD-pictogram "📶" om aan te geven dat het netwerk wordt ingesteld. Nadat het proces is voltooid, blijft het pictogram "📶" continu branden.

6.1 Instelling bedrade controller

De bedrade controllerinstellingen omvatten AP-MODUS en HERSTEL WLAN-INSTELLING.

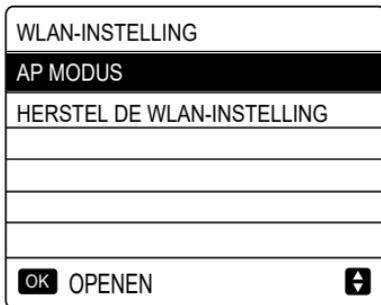

- Activeer de WLAN via interface. Ga naar "MENU" > "WLAN-INSTELLING" > "AP-MODUS".

Druk op "OK", de volgende pagina verschijnt:

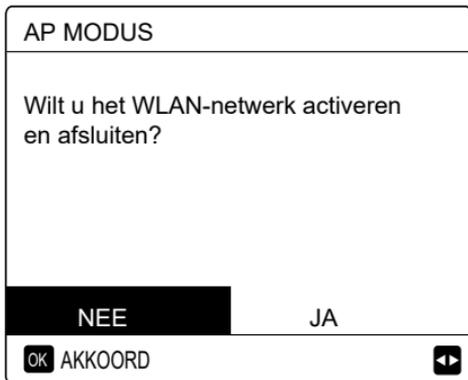

Gebruik "◀", "▶" om naar "JA" te gaan. Druk op "OK" om de AP-modus te selecteren. Selecteer de AP-modus op het mobiele apparaat en ga door met de vervolginstellingen volgens de APP-prompts.

OPGELET

Nadat de AP-modus is geactiveerd en er geen verbinding is met de mobiele telefoon, gaat het LCD-pictogram "📶" 10 minuten knipperen.

Als het is verbonden met de mobiele telefoon, blijft het pictogram "📶" continu branden.

- Herstel WLAN-instelling via interface. Ga naar "MENU" > "WLAN-INSTELLING" > "HERSTEL WLAN-INSTELLING". Druk op "OK", de volgende pagina verschijnt:

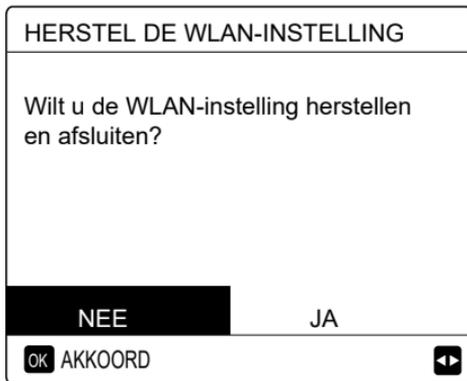

Gebruik "◀", "▶" om naar "JA" te gaan. Druk op "OK" om de WLAN-instelling te herstellen. Voer de bovenstaande bewerking uit en de draadloze configuratie wordt opnieuw ingesteld.

6.2 Instellingen mobiel apparaat

AP-modus is beschikbaar voor draadloze distributie aan de mobiele kant.

- AP-modus die WLAN verbindt:

6.2.1 Installeer APP

- ① Scan de volgende QR-code om de Smart Home APP te installeren.



- ② Zoek opnieuw in "MSmartLife" in APP STORE of GOOGLE PLAY om de APP te installeren.

Deze app is alleen van toepassing op Android 7.0 en IOS7 of nieuwere besturingssystemen.

6.2.2 Aanmelden / Registreren

Voer uw registratiecode in. Of scan de QR-code op de verpakking van de controller als deze bestond. En registreer uw account volgens de richtlijnen.

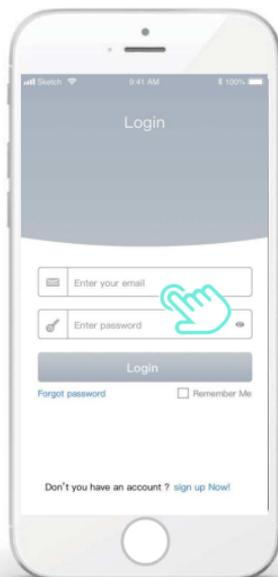
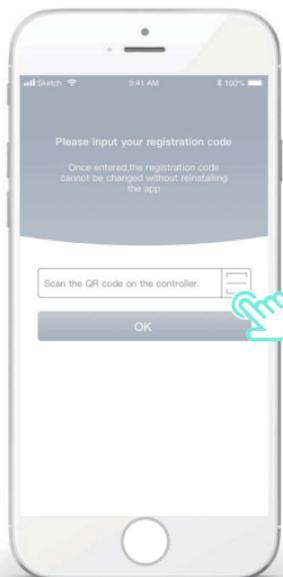

6.2.3 Huishoudapparaten toevoegen:

- 1) Voeg uw apparaat toe volgens de richtlijnen.

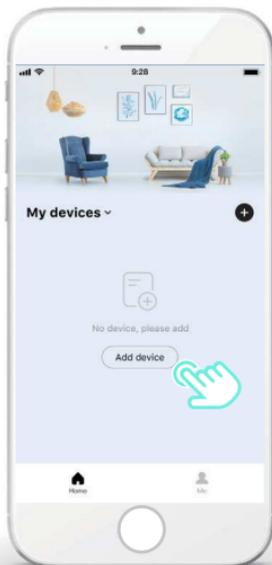

2) Bedien de bedrade controller volgens APP-aanwijzingen.



3) Wacht tot het huishoudapparaat verbinding maakt en klik op "Complete".

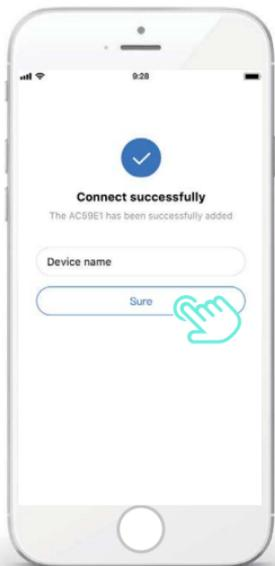

4) Nadat het apparaat is verbonden, blijft het LCD-pictogram "  " van de bedrade controller constant aan en de airconditioner kan worden bediend via de APP.

5) Als het netwerk distributieproces mislukt of als mobiel herstelt moet worden, voer dan "WiFi Factory Reset" uit op de bedrade controller en herhaal vervolgens het bovenstaande proces.

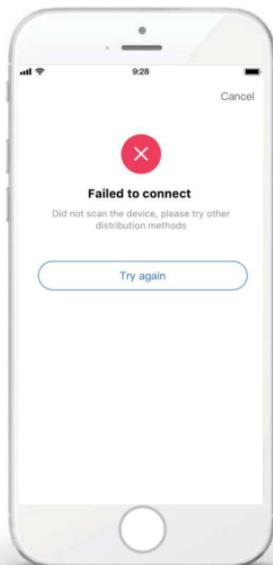



Waarschuwing en probleemoplossing voor netwerkfouten

Wanneer het product is verbonden met het netwerk, moet u ervoor zorgen dat de telefoon zich zo dicht mogelijk bij het apparaat bevindt.

Wij ondersteunen momenteel alleen 2,4 GHz-bandrouters.

Speciale tekens (leestekens, spaties, etc.) worden niet aanbevolen voor gebruik in de WLAN-naam.

Het wordt aanbevolen om niet meer dan 10 apparaten op één router aan te sluiten om te voorkomen dat huishoudelijke apparaten worden beïnvloed door een zwak of onstabiel netwerksignaal.

Als het wachtwoord van de router of Wi-Fi is gewijzigd, wist u alle instellingen en reset u het apparaat.

De inhoud van APP kan veranderen in versie-updates en de actuele werking zal prevaleren.

7 INSTALLATIEHANDLEIDING

7.1 Veiligheidsmaatregel

- Lees de veiligheidsmaatregelen aandachtig door voordat u het apparaat installeert.
- Hieronder worden belangrijke veiligheidskwesties vermeld waaraan moet worden voldaan.
- Als er na voltooiing geen abnormale verschijnselen zijn tijdens het testen, overhandig dan de handleiding aan de gebruiker.
- Betekenis van symbolen:



WAARSCHUWING

Betekent onjuiste behandeling kan leiden tot fataal ongeluk of ernstig letsel.



OPGELET

Betekent onjuiste behandeling kan leiden tot persoonlijk letsel of materiele schade.



WAARSCHUWING

Laat het apparaat door de distributeur of technici installeren.

Ondeskundige installatie kan leiden tot storingen, elektrische schokken of brand.

Volg de aanwijzingen in deze handleiding strikt op.

Onjuiste installatie kan elektrische schokken of brand veroorzaken.

Herinstallatie moet worden uitgevoerd door bekwame technici.

Onjuiste installatie kan elektrische schokken of brand veroorzaken.

Demonteer uw airconditioner niet zonder technische kennis.

Ondeskundige demontage kan een storingen en zelfs brand veroorzaken.

OPGELET

Installeer het apparaat niet op een plaats die mogelijk blootstaat aan ontvlambare gassen.

Als brandbare gassen ontsnappen en in contact komen met de bedrade controller, kan er brand ontstaan.

De bedrading moet geschikt zijn voor de spanning van de de bedrade controller.

Anders kan er elektrische lekkage of oververhitting optreden en dit kan brand veroorzaken.

De gespecificeerde kabels moeten op de bedrading worden aangesloten. Er mag geen externe druk op de terminal worden uitgeoefend.

Anders kan bedrading worden beschadigd en kan er oververhitting en brandgevaar ontstaan .

Plaats de bedrade afstandsbediening niet in de buurt van de lampen om te voorkomen dat het externe signaal van de afstandsbediening wordt gestoord. (zie afbeelding rechts)

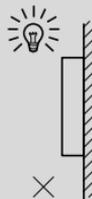

7.2 Overige voorzorgsmaatregelen

7.2.1. Installatielocatie

Installeer het apparaat niet op een plaats met veel olie, stoom of sulfidegas. Het apparaat kan vervormen en defect raken.

7.2.2 Voorbereiding voor installatie

1) Controleer of het volgende compleet is.

Nr.	Naam	Aantal	Opmerkingen
1	Bedrade controller	1	_____
2	Ronde houtschroef met ronde kop	3	Voor wandmontage
3	Montageschroef met ronde kop	2	Voor montage op de schakelkast
4	Installatie- en gebruikershandleiding	1	_____
5	Kunststof bout	2	Dit accessoire wordt gebruikt wanneer de gecentraliseerde besturing in de elektrische kast wordt geïnstalleerd
6	Kunststof expansiepijp	3	Voor wandmontage

7.2.3 Opmerking voor installatie van bedrade controller:

- 1) Deze installatiehandleiding bevat informatie over de installatieprocedure van de bedrade afstandsbediening. Raadpleeg de installatiehandleiding van de binnenunit voor de verbinding tussen de bedrade afstandsbediening en de binnenunit.
- 2) Het circuit van bedrade afstandsbediening is laagspanningscircuit. Sluit het nooit aan op een standaard 220V / 380V-circuit en plaats het niet in dezelfde bedradingsbuis met het circuit.
- 3) De afgeschermd kabel moet stabiel geaard worden om goed verbinding te verzekeren.
- 4) Probeer de afgeschermd kabel niet te verlengen door deze af te knippen. Gebruik indien nodig een verbindingaansluitblok.
- 5) Gebruik Megger nadat de verbinding is voltooid om de isolatie op de signaaldraad te controleren.

7.3 Installatieprocedure en bijpassende instelling van bedrade controller

7.3.1 Afmetingen van apparaat

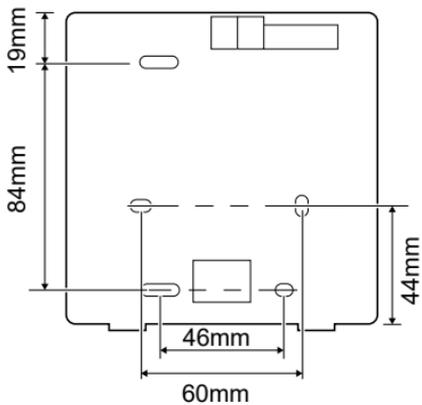
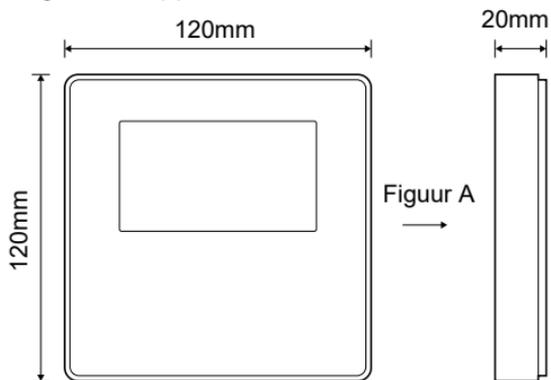

7.3.2 Bedrading

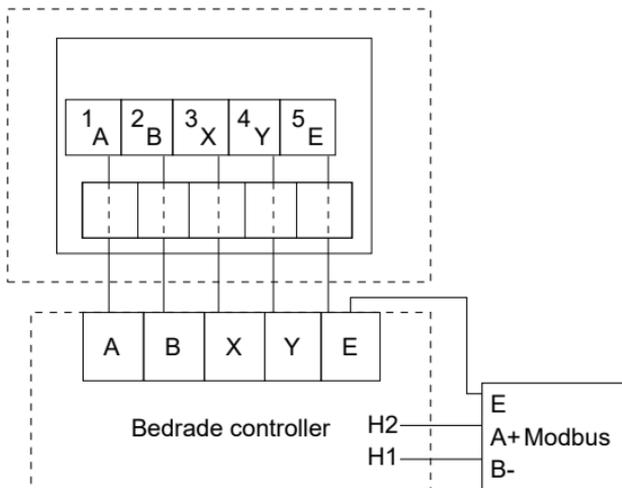

Ingangsspanning (A / B)	13,5 VAC
Bedradingsgrootte	0,75 mm ²

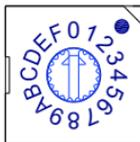

De roterende gecodeerde schakelaar S3 (0-F) op het hoofdbesturingsbord van de hydraulische module wordt gebruikt voor het instellen van het modbus-adres. Standaard hebben de eenheden deze gecodeerde schakelaar gepositioneerd op = 0, maar dit komt overeen met het modbus-adres 16, terwijl de andere posities overeenkomen met het nummer, b.v. pos = 2 is adres 2, pos = 5 is adres 5.

7.3.3 Installatie achterwand

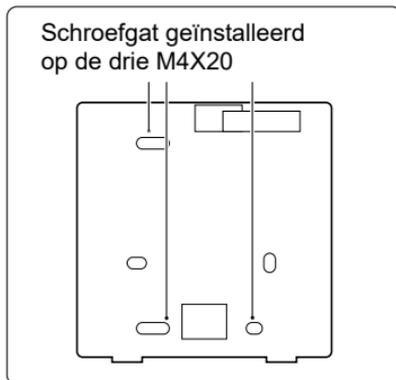
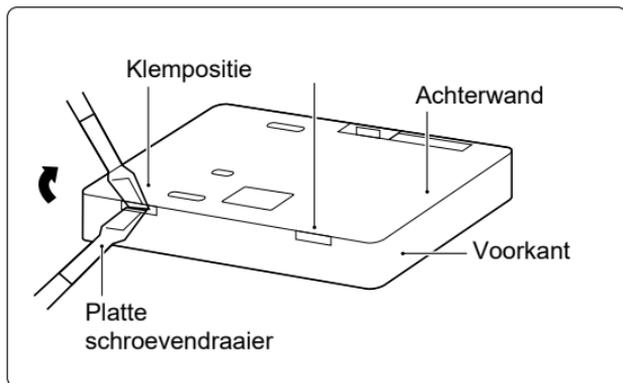

Schroefgat geïnstalleerd
op de drie M4X20

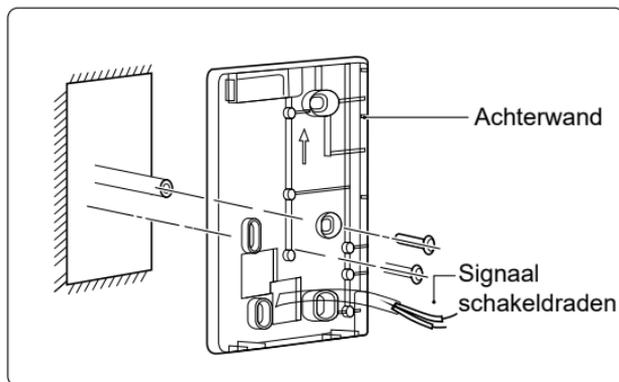

- 1) Gebruik een platte schroevendraaier om in de opening in de onderkant van de bedrade controller te steken en verdraai de schroevendraaier om de achterwand te verwijderen. (Let op de draairichting, anders raakt de achterklep beschadigd!)
- 2) Gebruik drie M4X20-schroeven om de achterwand direct op de muur te installeren.
- 3) Gebruik twee M4X25-schroeven om de achterwand op de 86 stroomkast te installeren en gebruik M4X20-schroeven voor bevestiging aan de muur.
- 4) Pas de lengte van twee plastic schroefstaven in het accessoire aan op de standaardlengte vanaf de schroefstang van de stroomkast tot aan de muur. Zorg ervoor dat u tijdens het installeren van de schroefstang plat tegen de muur wordt gemonteerd.
- 5) Gebruik kruiskopschroeven om de onderste kap van de bedrade controller in de muur te bevestigen door de schroefstang. Zorg ervoor dat de onderkant van de bedrade controller zich op hetzelfde niveau bevindt na de installatie en installeer vervolgens de bedrade controller aan de onderkant.
- 6) Overmatig vastdraaien van de schroef kan vervorming van de achterwand tot gevolg hebben.

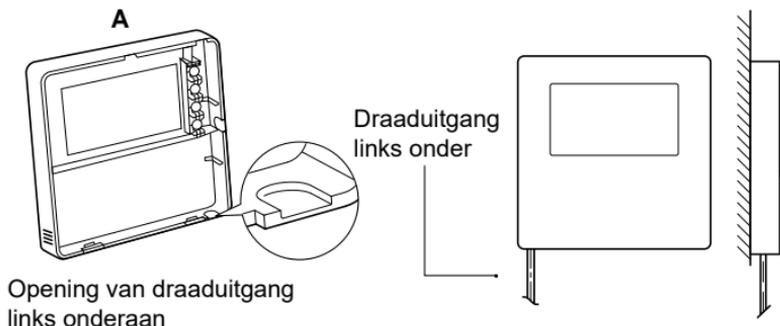

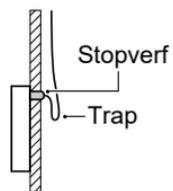
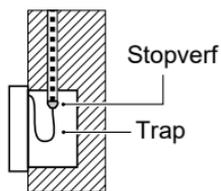
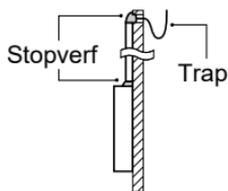
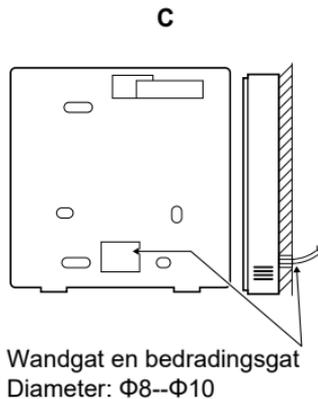
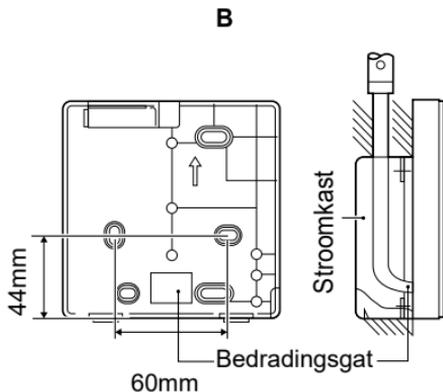

Voorkom dat er water in de bedrade afstandsbediening komt, gebruik een trap en stopverf om de connectoren van draden af te dichten tijdens de installatie van de bedrading.

7.4 Installatie voorwand

Monteer de voorwand en zet deze vast. Vermijd dat de communicatiedraad tijdens de installatie beklemd raakt.

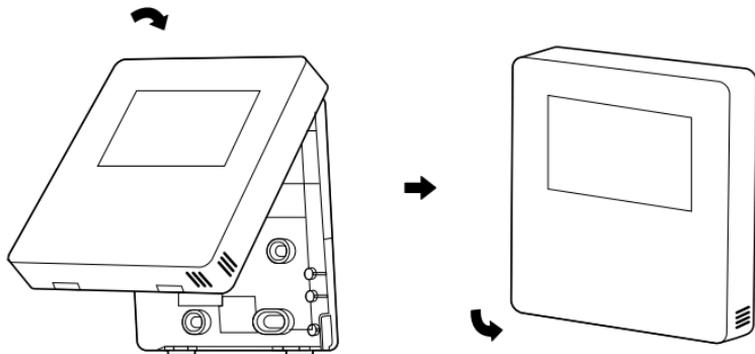

Sensor mag niet met vocht in aanraking komen.

Installeer de achterwand op de juiste manier en zet de voorwand en de achterwand stevig vast, anders kan de wand loskomen.



- Manualul oferă o descriere detaliată a măsurilor de precauție care trebuie luate în considerare în timpul funcționării.
- Pentru a asigura funcționarea corectă a telecomenzii cablate, citiți cu atenție acest manual înainte de a utiliza unitatea.
- Nu aruncați acest manual după ce l-ați citit, va fi util pentru consultare viitoare.

CUPRINS

1 GENERAL SAFETY PRECAUTIONS

- 1.1 Despre documentație 1
- 1.2 Pentru utilizator 2

2 PRIVIRE SUMARĂ ASUPRA INTERFEȚEI CU UTILIZATORUL

- 2.1 Dispunerea telecomenzii cablate 5
- 2.2 Pictograme de stare 6

3 UTILIZAREA PAGINILOR DE START

- 3.1 Despre paginile de start 7

4 STRUCTURA MENIULUI

- 4.1 Despre structura meniului..... 11
- 4.2 Accesarea structurii meniului 11
- 4.3 Parcurgerea structurii meniului 11

5 FUNCȚII DE BAZĂ

- 5.1 Deblocare ecran..... 12
- 5.2 Activarea/dezactivarea comenzilor..... 14
- 5.3 Reglarea temperaturii 19
- 5.4 Reglarea modului de funcționare în spațiu..... 22

6 Instrucțiuni pentru configurarea rețelei

- 6.1 Настройка проводного контроллера..... 25
- 6.2 Настройка мобильного устройства..... 28

7 MANUAL DE INSTALARE

- 7.1 Măsuri de siguranță 35
- 7.2 Alte măsuri de precauție 38
- 7.3 Procedura de instalare și setarea potrivită
a telecomenzii cablate 39
- 7.4 Instalarea capacului frontal 46

1 MĂSURI GENERALE PRIVIND SIGURANȚA

1.1 Despre documentație

- Documentația originală este elaborată în limba engleză. Toate celelalte limbi sunt traduceri.
- Măsurile de precauție descrise în acest document tratează teme foarte importante, respectați-le cu atenție.
- Toate activitățile descrise în manualul de instalare trebuie să fie efectuate de un instalator autorizat.

1.1.1 Semnificația avertismentelor și simbolurilor

PERICOL

Indică o situație care duce la deces sau vătămări grave.

PERICOL:RISC DE ELECTROCUTARE

Indică o situație care ar putea duce la electrocutare.

PERICOL:RISC DE ARDERE

Indică o situație care ar putea duce la arsuri cauzate de temperaturi extrem de ridicate sau scăzute.

AVERTISMENT

Indică o situație care ar putea duce la deces sau vătămări grave.

ATENȚIE

Indică o situație care ar putea conduce la vătămări minore sau moderate.

NOTĂ

Indică o situație care ar putea duce la deteriorarea echipamentului sau a bunurilor.

INFORMAȚII

Indică sfaturi utile sau informații suplimentare.

1.2 Pentru utilizator

- Dacă nu știți sigur cum să operați unitatea, contactați instalatorul.

- Unitatea nu este destinată utilizării de către copii sau persoane cu capacități fizice, senzoriale sau psihice reduse sau lipsite de experiență și cunoștințe, decât dacă sunt supravegheate sau instruite cu privire la utilizarea unității de către o persoană responsabilă pentru siguranța acestora. Copiii trebuie să fie supravegheați pentru a nu se juca cu produsul.



ATENȚIE

NU clătiți unitatea. Acest lucru poate cauza șocuri electrice sau incendii.



NOTĂ

- NU așezați obiecte sau echipamente pe unitate.
- NU vă așezați, nu vă urcați și nu stați în picioare pe unitate.

- Unitatea este marcată cu următorul simbol:



Aceasta înseamnă că produsele electrice și electronice nu pot fi amestecate cu deșeuri menajere nesortate. NU încercați să dezmembrați sistemul singuri: dezmembrarea sistemului și tratarea agentului frigorific, a uleiului și a altor componente trebuie efectuate de un instalator autorizat și trebuie să fie în conformitate cu legislația aplicabilă. Unitățile trebuie să fie duse la un centru specializat pentru reutilizare, reciclare și recuperare. Asigurându-vă că acest produs este eliminat corect, veți contribui la prevenirea eventualelor consecințe negative asupra mediului și sănătății umane. Pentru informații suplimentare, contactați instalatorul sau autoritatea locală.

2 PRIVIRE SUMARĂ ASUPRA INTERFEȚEI CU UTILIZATORUL

2.1 Dispunerea telecomenzii cablate

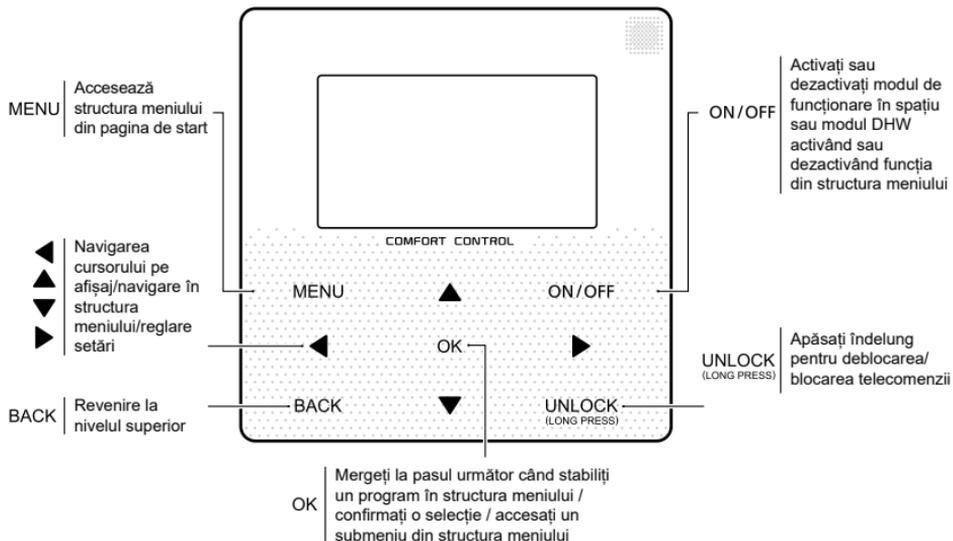

2.2 Pictograme de stare

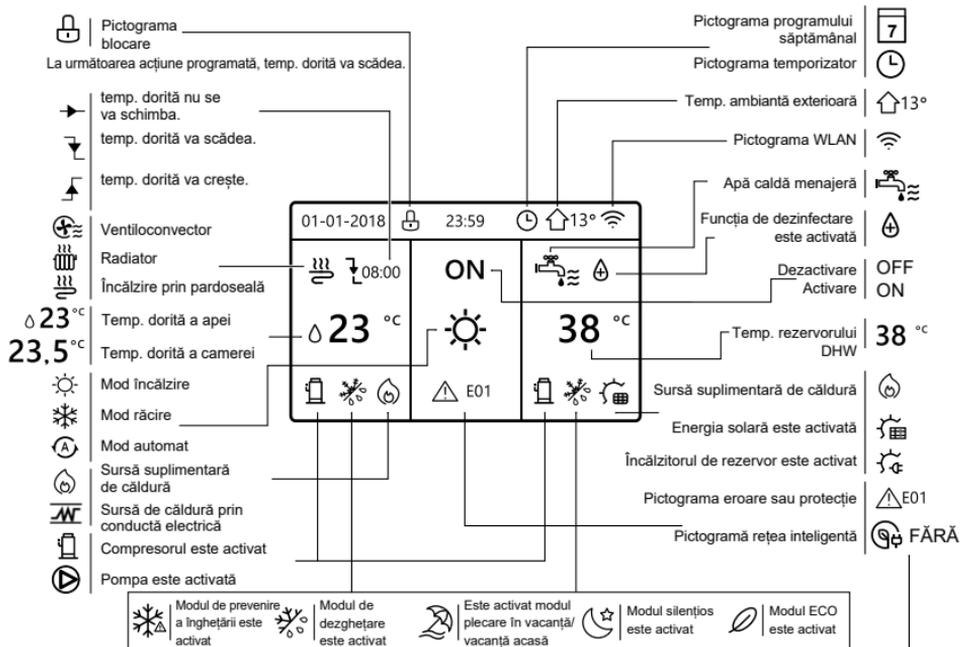

	Ventiloconvector	Radiator	Încălzire prin pardoseală	Apă caldă menajeră
ON (PORȚIT)				
OFF (OPRIȚ)				

	Fără electricitate	Consum min. de electricitate	Consum max. de electricitate
Rețea inteligentă	FĂRĂ	MINIM	MAXIM

3 UTILIZAREA PAGINILOR DE START

3.1 Despre paginile de start

Puteți utiliza paginile de start pentru a citi și modifica setările destinate utilizării zilnice. Ceea ce puteți vedea și face pe paginile de start este descris acolo unde este cazul. În funcție de disponerea sistemului, pot fi posibile următoarele pagini de start:

- Temperatura dorită a camerei (ROOM)
- Temperatura dorită a apei (MAIN)
- Temperatura actuală a rezervorului DHW (TANK)

DHW = apă caldă menajeră

pagina de start1:

În cazul în care WATER FLOW TEMP. (Temp. apei) este setată la YES (Da) și ROOM TEMP. Sistemul este prevăzut cu funcția de încălzire prin pardoseală și a apei menajere; se va afișa pagina de start 1:

NOTĂ

Toate imaginile din manual au scop explicativ, paginile reale de pe ecran pot fi ușor diferite.

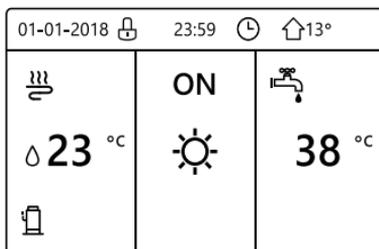

pagina de start2 :

În cazul în care WATER FLOW TEMP. (Temp. apei) este setată la NON (Nu) și ROOM TEMP. (Temp. camerei) este setată la YES (Da).Sistemul este prevăzut cu funcția de încălzire prin pardoseală și a apei menajere; se va afișa pagina de start 2:

NOTĂ

Telecomanda cablată trebuie instalată în camera cu încălzire prin pardoseală pentru a verifica temperatura camerei.

01-01-2018  23:59   13°		
 23.5 °C 	ON 	 38 °C

pagina de start3:

Dacă DHW MODE (Mod DHW) este setat la NON (Nu), și dacă „WATER FLOW TEMP. (Temp. apei) este setată la YES (Da), „ROOM TEMP.” (Temp camerei)” este setată la YES (Da). Va exista o pagină principală și una suplimentară. Sistemul este prevăzut cu funcția de încălzire prin pardoseală și a spațiului pentru ventiloconvector; se va afișa pagina de start 3:

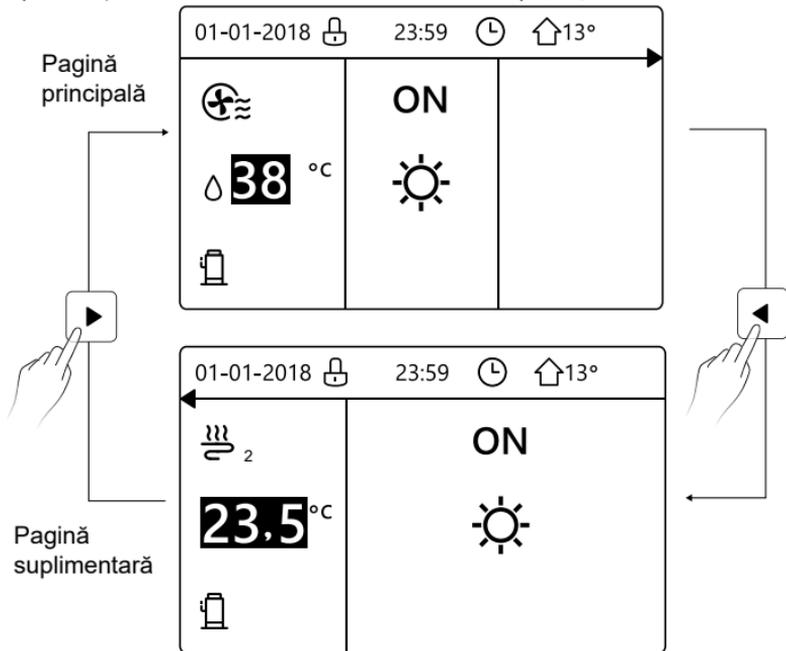

pagina de start4:

Dacă ROOM THERMOSTAT (Termostatul camerei) este setat la DOUBLE ZONE (Zonă dublă) sau DOUBLE ZONE este setat la YES (Da), va exista o pagină principală și una suplimentară. Sistemul este prevăzut cu funcție de încălzire prin pardoseală, încălzirea spațiului pentru ventiloconvector și a apei menajere; va apărea pagina de start 4:

Pagină
principală

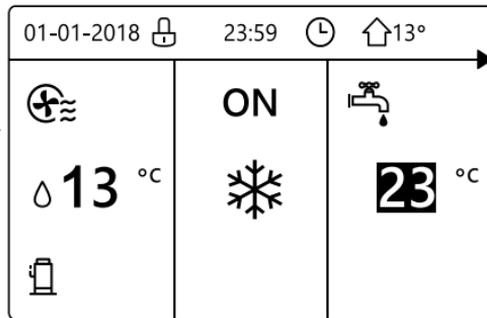

Pagină
suplimentară

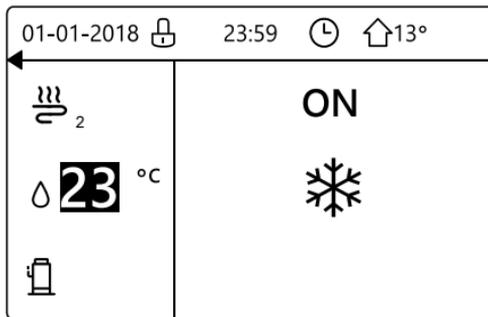

4 STRUCTURA MENIULUI

4.1 Despre structura meniului

Puteți utiliza structura meniului pentru a citi și configura setările care NU sunt destinate utilizării zilnice. Ceea ce puteți vedea și face în structura de meniu este descris acolo unde este cazul.

4.2 Accesarea structurii meniului

Din pagina de pornire, apăsați „MENU” (Meniu). Rezultat: apare structura meniului:

MENU	1/2	MENU	2/2
MOD DE FUNCT		INFORM. DE SERVICE	
TEMP. PRESETATA		PARAMETRI FUNCTION	
APĂ CALDĂ MENAJ. (ACM)		PT.SERVICE	
PROGRAM		SETARI WLAN	
OPTIUNI			
BL.COPII			
OK ENTER	↓	OK ENTER	↓

4.3 Parcurgerea structurii meniului

Utilizați „▼”, „▲” pentru a defila.

5 FUNCȚII DE BAZĂ

5.1 Deblocare ecran

Dacă pictograma  se află pe ecran, telecomanda este blocată. Se afișează următoarea pagină:

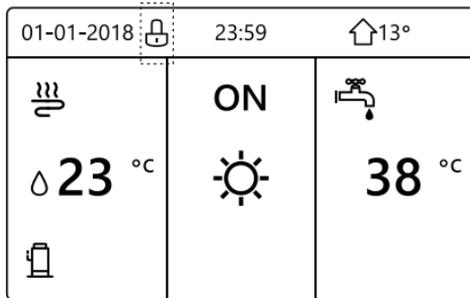

Apăsați orice tastă; pictograma  va clipi. Apăsați lung tasta „UNLOCK” (Deblocare). Pictograma  va dispărea, interfața poate fi controlată.

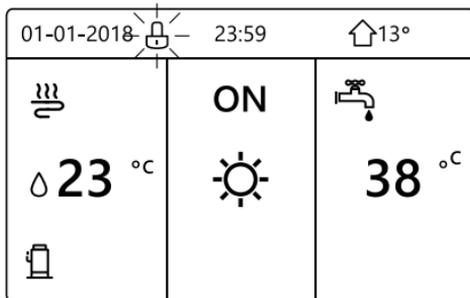

Interfața va fi blocată dacă nu există nicio mișcare timp îndelungat (aproximativ 120 de secunde). Dacă interfața este deblocată, apăsați lung „unlock (deblocare)” și interfața va fi blocată.

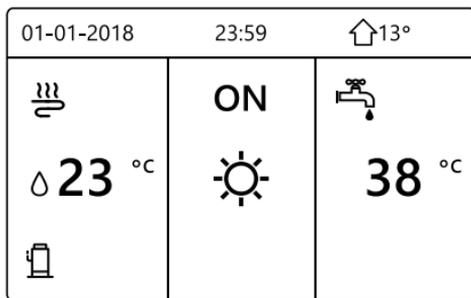

Apăsați lung
UNLOCK
(Deblocare)



Apăsați lung
UNLOCK
(Deblocare)

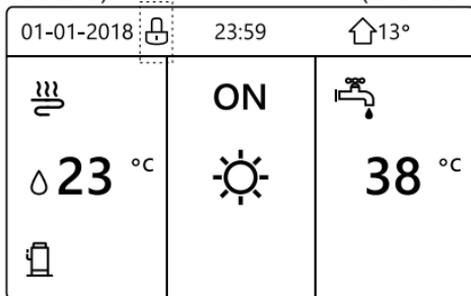

5.2 Activarea/dezactivarea comenzilor

Utilizați interfața pentru a porni sau opri unitatea pentru încălzirea sau răcirea spațiului.

- Pornirea/oprirea unității poate fi controlată de interfață dacă ROOM THERMOSTAT (Termostat cameră) este NON (Nu). [consultați „ROOM THERMOSTAT SETTING” (Setarea termostatului camerei) în „Manualul de instalare și utilizare (unitate interioară split M-thermal)”].
- Apăsați „◀”, „▶” pe pagina de start; va apărea cursorul negru:

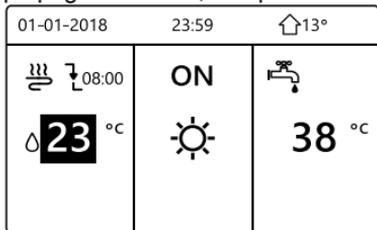

1) Când cursorul se află pe partea de modul de operare asociat temperaturii spațiului (inclusiv modul de încălzire ❄️, modul ☀️ de răcire și modul automat Ⓐ), apăsați tasta „ON/OFF (Pornit/Oprit)” pentru a porni/opri încălzirea sau răcirea spațiului.

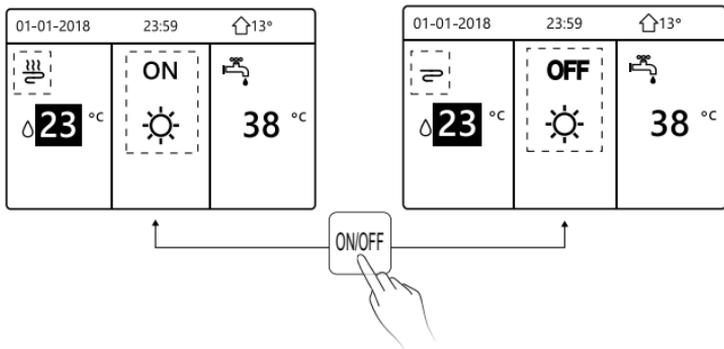

Dacă DHW TYPE (Tip apă caldă menajeră) este setat la NON (Nu), atunci se vor afișa următoarele pagini:

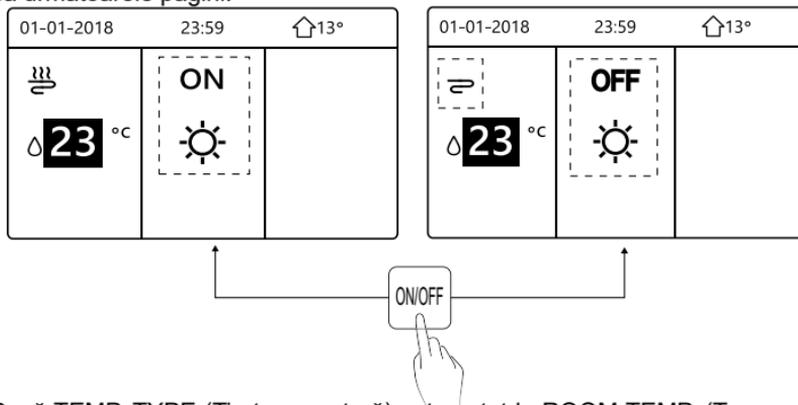

Dacă TEMP. TYPE (Tip temperatură) este setat la ROOM TEMP. (Temp. cameră), atunci se vor afișa următoarele pagini:

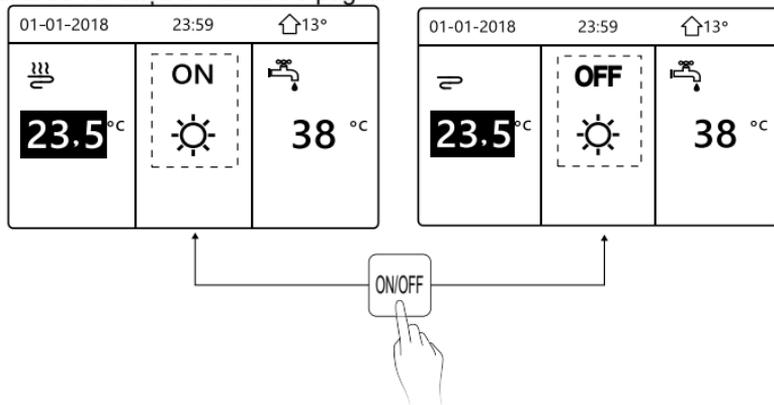

Utilizați termostatul de cameră pentru a porni sau opri încălzirea sau răcirea spațiului de către unitate.

① Termostatul de cameră nu este setat la SET NON (Setare nu) [consultați „ROOM THERMOSTAT SETTING” (Setarea termostatalui camerei) în „Manualul de instalare și utilizare (unitate interioară split M-thermal)”]. Unitatea pentru încălzirea sau răcirea spațiului este pornită sau oprită de termostatul de cameră, apăsând pe ON/OFF (Pornit/Oprit) pe interfață, se va afișa următoarea pagină:

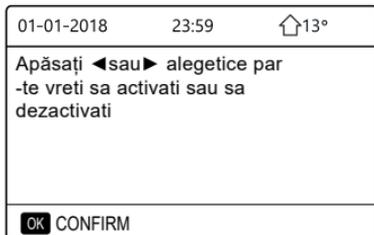

② Termostatul de cameră este setat la SET DOUBLE ZONE (Setare zonă dublă) [consultați „ROOM THERMOSTAT SETTING” (Setarea termostatalui camerei) în „Manualul de instalare și utilizare (unitate interioară split M-thermal)”]. Termostatul de cameră al ventilconvectorului este oprit, termostatul de cameră pentru încălzirea prin pardoseală este pornit, iar unitatea funcționează, dar afișajul este stins. Se afișează următoarea pagină:

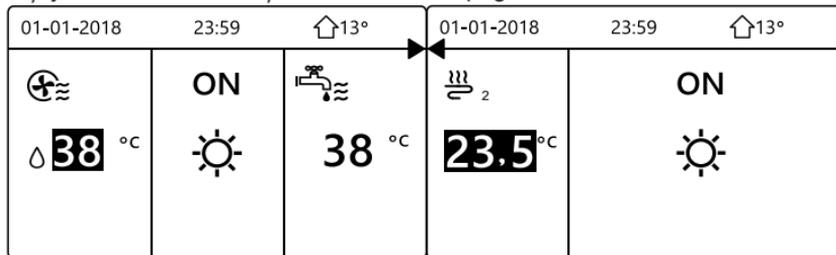

01-01-2018 23:59  13°			01-01-2018 23:59  13°		
	OFF			OFF	
 38 °C		38 °C	23.5 °C		

Utilizați interfața pentru a porni sau opri unitatea pentru DHW.
 Apăsați „▶”, „◀”, „▼” pe pagina de start; va apărea cursorul negru:

01-01-2018 23:59  13°		
	ON	
 23 °C		38 °C

2) Atunci când cursorul este pe temperatura apei calde menajere, apăsați tasta „ON/OFF (Pornit/Oprit)” pentru a porni/opri modul DHW (de preparare a apei calde menajere).

Dacă modul de operare în spațiu este activat, atunci se vor afișa următoarele pagini:

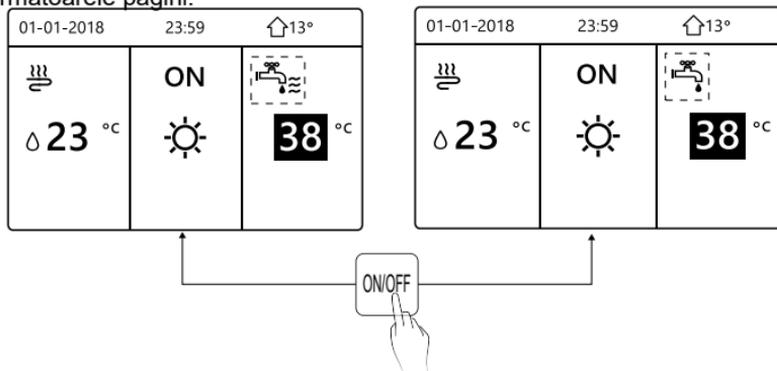

Dacă modul de operare în spațiu este dezactivat, atunci se vor afișa următoarele pagini:

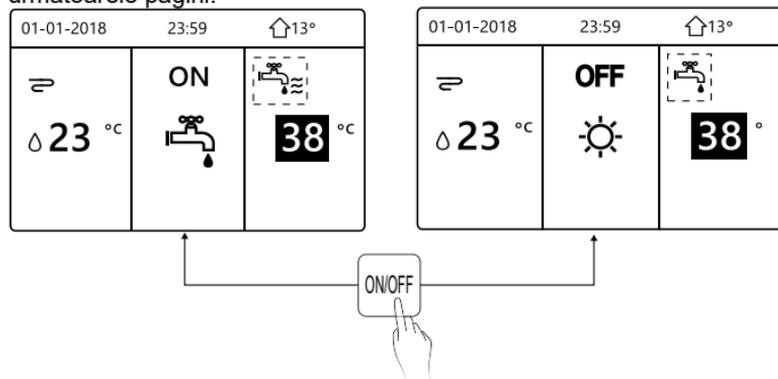

5.3 Reglarea temperaturii

Apăsăți „◀”, „▲” pe pagina de start; va apărea cursorul negru:

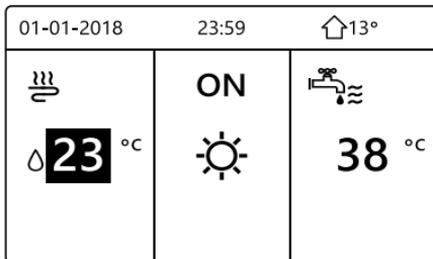

- În cazul în care cursorul este pe temperatură, folosiți „◀”, „▶” pentru a selecta și folosiți „▼”, „▲” pentru a regla temperatura.

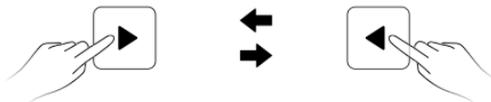
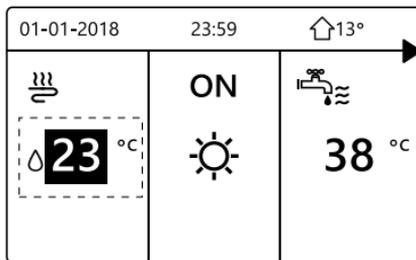

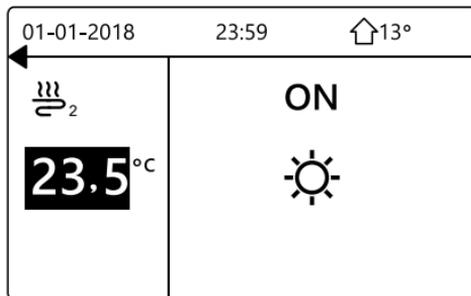
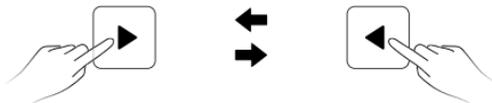
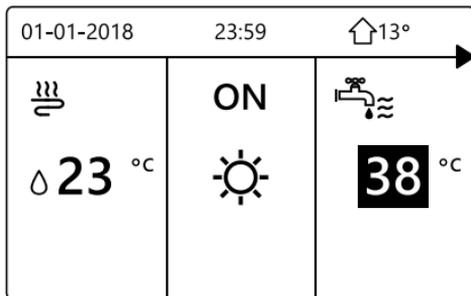

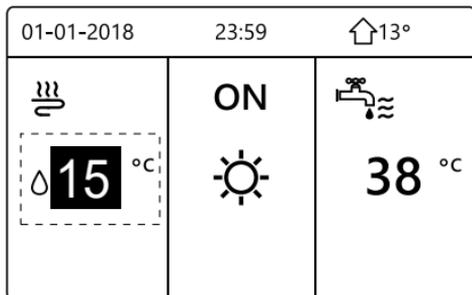
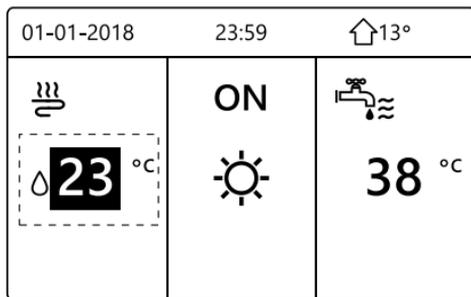

5.4 Reglarea modului de funcționare în spațiu

- Reglarea modului de funcționare în spațiu folosind interfața Accesați „MENU” > „OPERATION MODE” (Meniu > Mod de operare). Apăsând „OK”, se va afișa următoarea pagină:

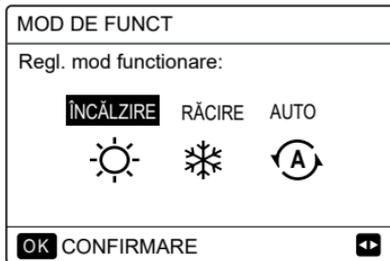

- Se pot selecta trei moduri, inclusiv HEAT, COOL și AUTO (Încălzire, Răcire și Auto). Utilizați „◀”, „▶” pentru a defila, apăsați „OK” pentru a selecta. Chiar și dacă nu apăsați butonul OK și părăsiți pagina, apăsând butonul BACK (Înapoi), modul va continua să se aplice în cazul în care cursorul a fost mutat în modul de operare.

Dacă există doar modul HEAT(COOL) [Încălzire (Răcire)], se va afișa următoarea pagină:

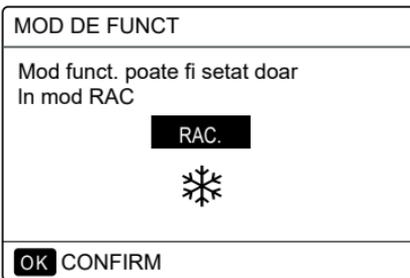
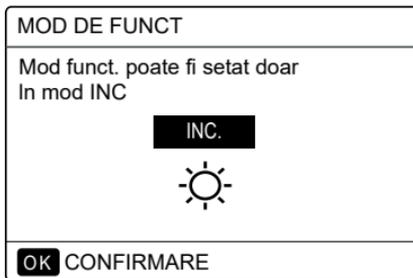

- Modul de operare nu poate fi modificat.

Dacă selecțați...	Atunci modul de operare în spațiu este...
 ÎNCĂLZIRE	Mod de încălzire permanent
 RĂCIRE	Mod de răcire permanent
 AUTO	<p>Modificat automat de software pe baza temperaturii exterioare (și în funcție de setările de instalare ale temperaturii interioare) și ia în considerare restricțiile lunare.</p> <p>Notă: schimbarea automată este posibilă numai în anumite condiții.</p> <p>Consultați „FOR SERVICEMAN”> „AUTO MODE SETTING” (Pentru instalator>Setare mod auto) în „Manualul de instalare și utilizare (unitate interioară split M-thermal)”.</p>

- Reglați modul de operare în spațiu de către termostatul de cameră, consultați „ROOM THERMOSTAT (Termostat de cameră)” din „Manualul de instalare și utilizare (unitate interioară split M-thermal)”.

Accesați „MENU”>„OPERATION MODE” (Meniu>Mod de operare). Dacă apăsați orice tastă pentru a selecta sau regla, se va afișa următoarea pagină:

01-01-2018	23:59	↑13°
Modul de RAC./INC. este controlat de termost. de cam		
Reglati modul de functionare de la termostatul de cam.		
OK CONFIRMARE		

6 Instrucțiuni pentru configurarea rețelei

- Telecomanda cablată oferă control inteligent cu ajutorul unui modul încorporat care primește semnal de comandă de la aplicație.
- Înainte de conectarea WLAN, verificați dacă routerul dvs. este activ și asigurați-vă că telecomanda cablată este conectată la semnalul wireless. În timpul procesului de partajare wireless, pictograma LCD „” clipește
- pentru a indica faptul că rețeaua este implementată. După finalizarea procesului, pictograma „” va rămâne permanent luminată.

6.1 Setarea telecomenzii cablate

Setările telecomenzii cablate includ AP MODE (Mod AP) și RESTORE WLAN SETTING (Resetare WLAN).

SETARI WLAN
MOD AP
RESETAB. SETARICE WLAN
OK ENTER 

- Activarea WLAN folosind interfața. Accesați „MENU” > „WLAN SETTING” > „AP MODE” (Meniu > Setare WLAN > Mod AP). Apăsând „OK”, se va afișa următoarea pagină:

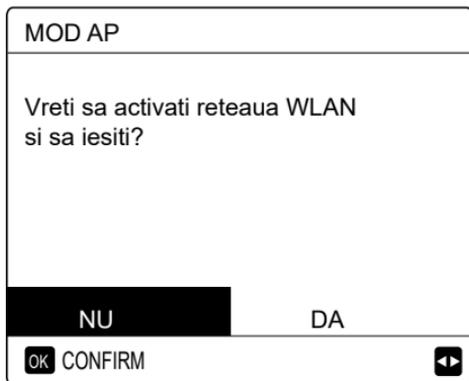

Utilizați „◀” și „▶” pentru a ajunge la „YES (Da)” și apăsați „OK” pentru a selecta modul AP. Selectați Modul AP corespunzător pe dispozitivul mobil și continuați setările ulterioare în conformitate cu solicitările aplicației.

ATENȚIE

După accesarea modului AP, dacă nu există conexiune cu telefonul mobil, pictograma LCD „📶” va clipi timp de 10 minute, după care va dispărea.

Dacă există conexiune cu telefonul mobil, pictograma „📶” va fi luminată permanent.

- Restaurarea setării WLAN folosind interfața. Accesați „MENU” > „WLAN SETTING” > „RESTORE WLAN SETTING” (Meniu > Setare WLAN > Resetare WLAN). Apăsând „OK”, se va afișa următoarea pagină:

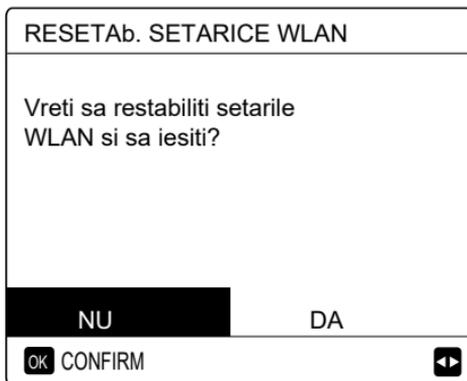

Utilizați „◀” și „▶” pentru a ajunge la „YES (Da)” și apăsați „OK” pentru a reseta WLAN. Finalizați operațiunea de mai sus și configurația wireless este resetată.

6.2 Setarea dispozitivului mobil

Modul AP este disponibil pentru partajarea wireless de pe un dispozitiv mobil.

- Conectarea Modulului AP la WLAN:

6.2.1 Instalați aplicația

- ① Scațați următorul code QR pentru a instala aplicația Smart Home.



- ② Căutați „MSmartLife” în APP STORE sau GOOGLE PLAY pentru a instala aplicația.

Această aplicație este aplicabilă numai pentru Android 7.0 și IOS7 sau pentru sisteme de operare mai noi.

6.2.2 Autentificați-vă/înregistrați-vă

Vă rugăm să introduceți codul dvs. de înregistrare. Sau scanați codul QR pe cutia de ambalare a controlerului dacă există. Și înregistrați-vă contul în conformitate cu îndrumările

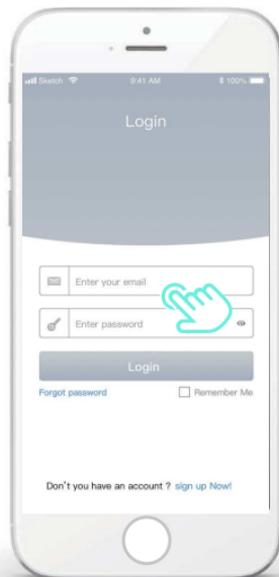
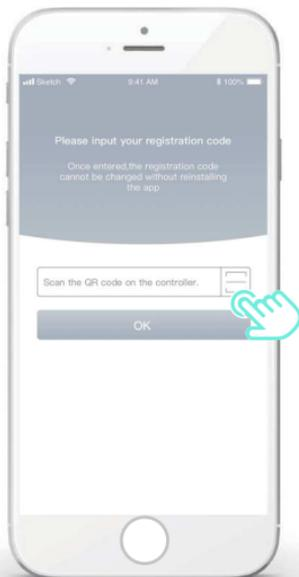

6.2.3 Adăugarea de electrocasnice:

1) Adăugați dispozitivul urmând instrucțiunile.

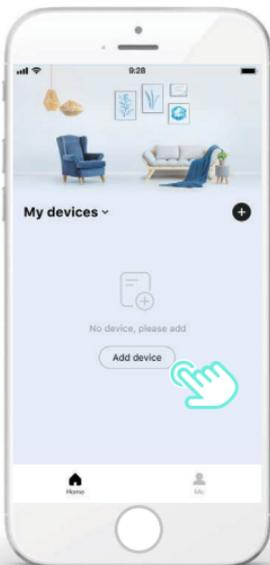

2) Acționați telecomanda cablată conform indicațiilor aplicației.



3) Așteptați conectarea aparatului electrocasnic și faceți clic pe „Complete” (Finalizare).

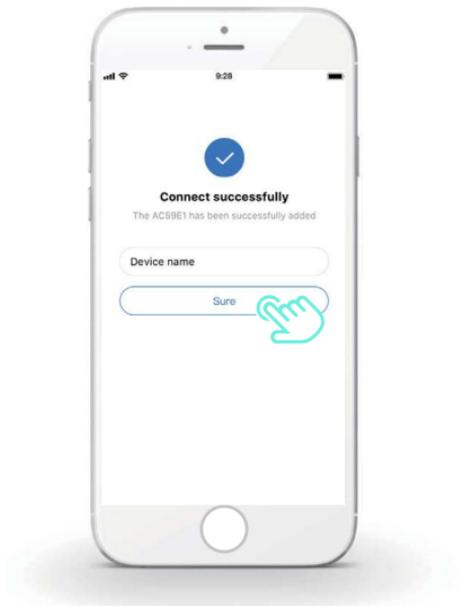

4) După ce aparatul este conectat, pictograma LCD „” a telecomenzii cablate rămâne luminată permanent, iar aparatul de aer condiționat poate fi controlat prin intermediul aplicației.

5) Dacă procesul de partajare a rețelei nu a reușit sau conexiunea mobilă solicită reconectarea și înlocuirea, acționați „WiFi Factory Reset” (Resetare WiFi la setările din fabrică) pe telecomanda cablată, apoi repetați procesul de mai sus.

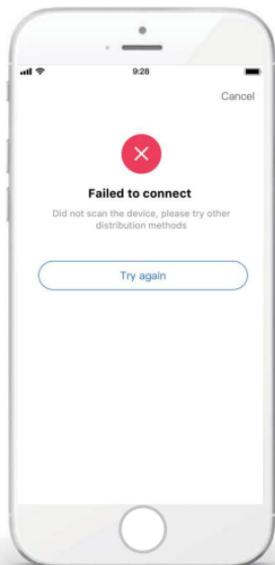



Avertismente și remedierea defecțiunilor din rețea

Când produsul este conectat la rețea, asigurați-vă că telefonul este cât mai aproape de produs.

În prezent, se acceptă doar routere cu bandă de 2,4 GHz.

Nu se recomandă caractere speciale (punctuație, spații etc.) ca parte a numelui WLAN.

Se recomandă să nu conectați mai mult de 10 dispozitive la un singur router, pentru ca aparatele de uz casnic să nu fie afectate de semnalul de rețea slab sau instabil.

Dacă parola routerului sau pentru Wi-Fi este schimbată, ștergeți toate setările și resetați aparatul.

Conținutul aplicației se poate modifica în versiunile actualizate, iar modul de funcționare curent va avea prioritate.

7 MANUAL DE INSTALARE

7.1 Măsurile de siguranță

- Citiți cu atenție măsurile de siguranță înainte de instalarea unității.
- În continuare sunt prezentate aspecte importante legate de siguranță care trebuie respectate.
- Confirmați că nu există fenomene anormale în timpul funcționării de probă după finalizarea instalării, apoi înmânați manualul utilizatorului.
- Semnificația marcajelor:



AVERTISMENT

Înseamnă că manipularea necorespunzătoare poate duce la deces sau vătămare personală gravă.



ATENȚIE

Înseamnă că manipularea necorespunzătoare poate duce la vătămare personală sau pagube materiale.



AVERTISMENT

Vă rugăm să permiteți distribuitorului sau profesioniștilor să instaleze unitatea.

Instalarea de către alte persoane poate duce la instalarea inadecvată, la electrocutare sau la un incendiu.

Respectați cu strictețe acest manual.

Instalarea necorespunzătoare poate duce la electrocutare sau un incendiu.

Reinstalarea trebuie efectuată de către profesioniști.

Instalarea necorespunzătoare poate duce la electrocutare sau un incendiu.

Nu dezamblați aparatul de aer condiționat fără motiv.

O dezamblare aleatorie poate provoca funcționarea anormală sau încălzirea, care poate duce la un incendiu.

ATENȚIE

Nu instalați unitatea într-un loc unde există posibilitatea de scurgeri de gaze inflamabile.

În cazul în care gaze inflamabile se acumulează în jurul telecomenzii cablate, se poate produce un incendiu.

Cablajul trebuie să fie adaptat curentului telecomenzii cablate.

În caz contrar, pot apărea scurgeri electrice sau încălzire și se poate produce un incendiu.

Pentru cablare, se vor utiliza cablurile specificate. Evitați aplicarea oricărei forțe externe asupra terminalului.

În caz contrar, pot apărea secționări ale firelor sau încălzire și se poate produce un incendiu.

Nu așezați telecomanda cablată lângă lămpi, pentru a evita perturbarea semnalului de la telecomandă. (consultați figura din partea dreaptă)



7.2 Alte măsuri de precauție

7.2.1. Locul de instalare

Nu instalați unitatea într-un loc cu mult ulei, abur, gaz sulfurat.
În caz contrar, produsul se poate deforma și defecta.

7.2.2 Pregătirea înainte de instalare

1) Verificați dacă următoarele ansambluri sunt complete.

Nr.	Nume	Cant.	Observații
1	Telecomandă cablată	1	_____
2	Șurub cu cap rotund, în cruce, pentru fixare în lemn	3	Pentru montare pe perete
3	Șurub de fixare cu cap rotund, în cruce	2	Pentru montare pe cutia de comutație electrică
4	Manual de instalare și de utilizare	1	_____
5	Șurub de plastic	2	Acest accesoriu este utilizat la instalarea controlului centralizat în interiorul dulapului electric
6	Țeavă de expansiune din plastic	3	Pentru montare pe perete

7.2.3 Notă pentru instalarea telecomenzii cablate:

- 1) Acest manual de instalare conține informații despre procedura de instalare a telecomenzii cablate. Consultați manualul de instalare a unității interioare pentru conexiunea dintre telecomanda cablată și unitatea interioară.
- 2) Circuitul telecomenzii cablate este un circuit de joasă tensiune. Nu îl conectați niciodată cu un circuit standard de 220 V/380 V și nu îl includeți în același tub de cablare cu circuitul.
- 3) Cablul ecranat trebuie să fie conectat stabil la sol, altfel transmisia se poate defecta.
- 4) Nu încercați să extindeți cablul ecranat prin tăiere; dacă este necesar, utilizați blocul de conexiuni terminale pentru conectare.
- 5) După finalizarea conexiunii, folosiți un megohmetru pentru a verifica izolația cablului de semnal.

7.3 Procedura de instalare și setarea potrivită a telecomenzii cablate

7.3.1 Figura cu dimensiunile structurii

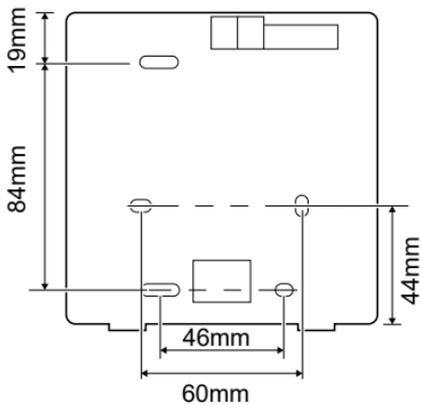
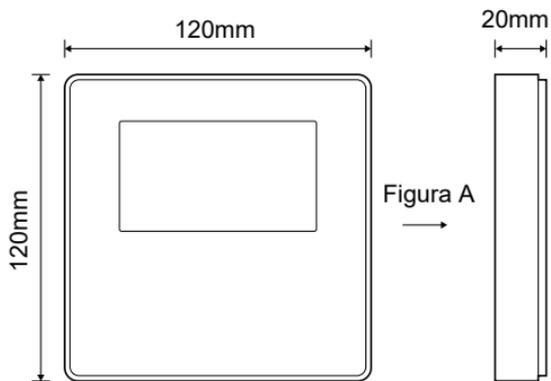

7.3.2 Cablare

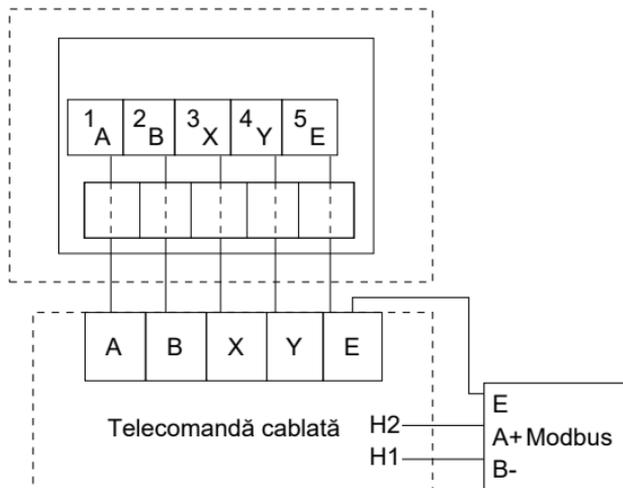

Tensiune de intrare (A/B)	13,5 V c.a.
Dimensiunea cablajului	0,75 mm ²

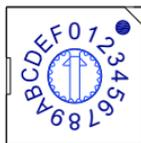

Comutatorul rotativ codat S3 (0-F) de pe placa de comandă principală a modului hidraulic este utilizat pentru setarea adresei modbus.

În mod implicit, unitățile au acest comutator codat în poziția = 0, dar acesta corespunde adresei modbus 16, în timp ce celelalte poziții corespund numerelor, de exemplu, poz. = 2 este adresa 2, poz. = 5 este adresa 5.

7.3.3 Instalarea capacului posterior

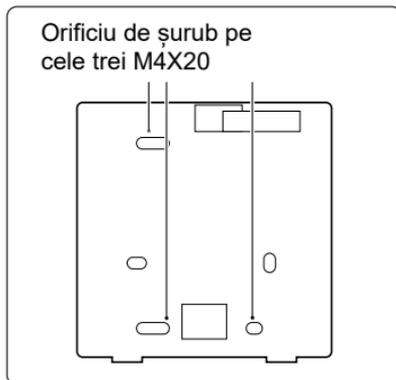
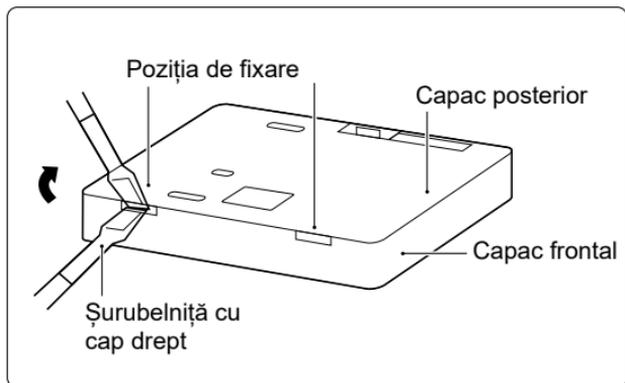

Orificiu de șurub pe
cele trei M4X20

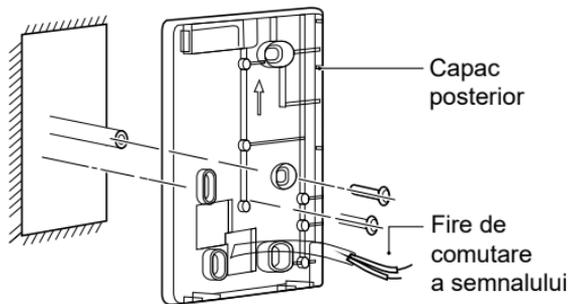
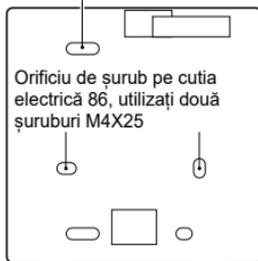

- 1) Folosiți șurubelnița cu cap drept pentru a introduce în poziția de fixare în partea inferioară a telecomenzii cablate și rotiți șurubelnița pentru a scoate capul posterior. (Acordați atenție la direcția de rotire, în caz contrar capul posterior se va deteriora!)
- 2) Folosiți trei șuruburi M4X20 pentru a instala direct capul posterior pe perete.
- 3) Folosiți două șuruburi M4X25 pentru a instala capul posterior pe cutia electrică 86 și utilizați un șurub M4X20 pentru fixarea pe perete.
- 4) Reglați lungimea a două bare cu șurub din plastic din accesoriu pentru a avea lungimea standard de la bara cu șurub a cutiei electrice la perete. La instalarea barei cu șurub pe perete, asigurați-vă că urmează planeitatea peretelui.
- 5) Utilizați șuruburi cu cap în cruce pentru a fixa capul inferior al telecomenzii cablate în perete prin bara cu șurub. Capul inferior al telecomenzii cablate trebuie să fie la nivel după instalare și apoi instalați telecomanda cablată înapoi pe capul inferior.
- 6) Strângerea excesivă a șurubului, va duce la deformarea capului posterior.

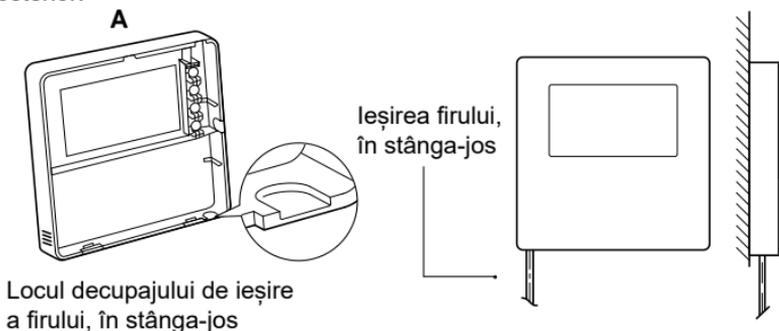

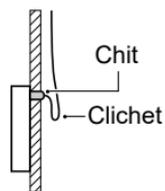
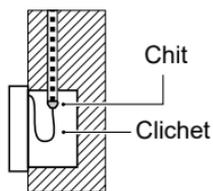
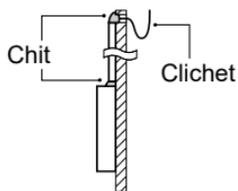
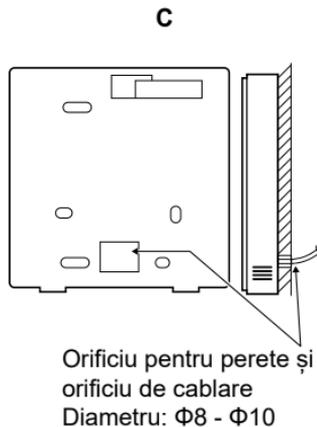
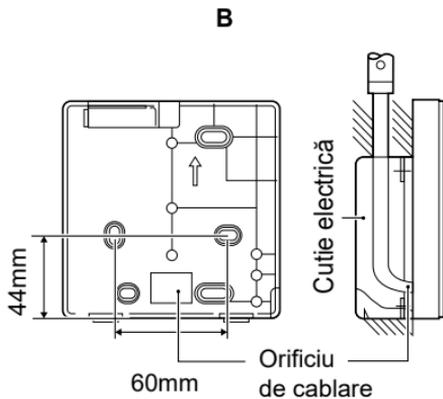

Evitați intrarea apei în telecomanda cablată, folosiți clichetul și chitul pentru a sigila conectorii firelor în timpul realizării cablajului.

7.4 Instalarea capacului frontal

După reglarea și fixarea capacului frontal, evitați prinderea cablului de comutare a comunicării în timpul instalării.

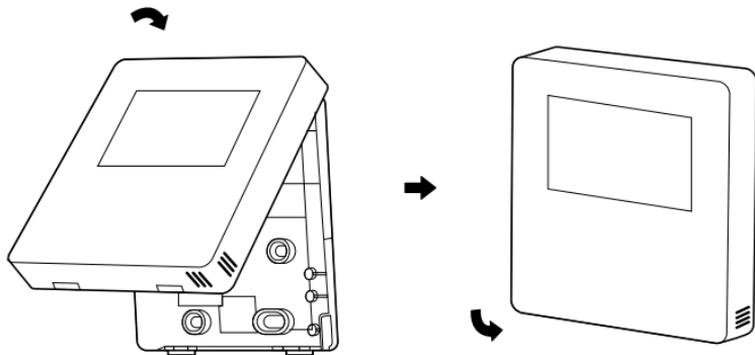

Evitați prezența umezelii în preajma senzorului.

Instalați corect capacul posterior și fixați ferm capacul frontal și capacul posterior, altfel capacul frontal va cădea.



- В данном руководстве представлено подробное описание мер предосторожности, на которые следует обратить внимание во время работы.
- Чтобы обеспечить надлежащее обслуживание проводного пульта управления, перед использованием устройства внимательно прочитайте данное руководство.
- После прочтения сохраните данное руководство для удобства использования в будущем.

СОДЕРЖАНИЕ

1 ОБЩИЕ МЕРЫ ПРЕДОСТОРОЖНОСТИ

- 1.1 Сведения о документации 1
- 1.2 Для пользователя 2

2 ОБЗОР ПОЛЬЗОВАТЕЛЬСКОГО ИНТЕРФЕЙСА

- 2.1 Внешний вид проводного пульта управления 5
- 2.2 Значки состояния 6

3 ИСПОЛЬЗОВАНИЕ ДОМАШНИХ СТРАНИЦ

- 3.1 О домашних страницах 7

4 СТРУКТУРА МЕНЮ

- 4.1 Сведения о структуре меню 11
- 4.2 Переход к структуре меню 11
- 4.3 Навигация в структуре меню 11

5 ПОРЯДОК ИСПОЛЬЗОВАНИЯ

- 5.1 Разблокировка экрана 12
- 5.2 Органы управления включением/
выключением ON/OFF 14
- 5.3 Регулировка температуры 19
- 5.4 Регулировка режима работы в помещении 22

6 Руководящие указания по настройке конфигурации сети

- 6.1 Настройка проводного контроллера 25
- 6.2 Настройка мобильного устройства 28

7 РУКОВОДСТВО ПО УСТАНОВКЕ

- 7.1 Меры предосторожности, обеспечивающие
безопасность 35
- 7.2 Прочие меры предосторожности 38
- 7.3 Процедура установки и настройка проводного
пульта управления 39
- 7.4 Установка передней крышки 46

1 ОБЩИЕ МЕРЫ ПРЕДОСТОРОЖНОСТИ

1.1 Сведения о документации

- Языком оригинала является английский. Документация на всех остальных языках является переводом.
- Меры предосторожности, описанные в этом документе, касаются очень важных вопросов, будьте внимательны при их выполнении.
- Все действия, изложенные в «Руководстве по установке» должны выполняться уполномоченным обслуживающим персоналом.

1.1.1 Значение предупреждений и символов

ОПАСНОСТЬ

Указывает на ситуацию, которая приводит к смерти или серьезным травмам.

ОПАСНОСТЬ:РИСК ПОРАЖЕНИЯ ЭЛЕКТРИЧЕСКИМ ТОКОМ

Указывает на ситуацию, которая может привести к поражению электрическим током.

ОПАСНОСТЬ:РИСК ОЖОГА

Указывает на ситуацию, которая может привести к ожогу из-за наличия экстремально высоких или низких температур.



ПРЕДУПРЕЖДЕНИЕ

Указывает на ситуацию, которая может привести к смерти или серьезным травмам.



ВНИМАНИЕ!

Указывает на ситуацию, которая может привести к травме легкой или средней тяжести.



ПРИМЕЧАНИЕ.

Указывает на ситуацию, которая может привести к повреждению оборудования или имущества.



ИНФОРМАЦИЯ

Обозначает полезные советы или дополнительную информацию.

1.2 Для пользователя

- Если вы не вполне уверены, что знаете, как управлять устройством, обратитесь к обслуживающему персоналу.

- Устройство не предназначено для использования лицами, в том числе детьми, с ограниченными физическими, сенсорными или умственными способностями, или не имеющими достаточного опыта и знаний, если только они не находятся под контролем или не получили инструкции относительно использования устройства от лица, ответственного за их безопасность. Не разрешайте детям играть с продуктом.



ВНИМАНИЕ!

НЕ промывайте устройство. Это может привести к поражению электрическим током или пожару.



ПРИМЕЧАНИЕ.

- ЗАПРЕЩЕНО класть какие-либо предметы или оборудование на верхнюю часть устройства.
- ЗАПРЕЩЕНО садиться, взбираться или вставать на устройство.

- Блоки обозначены следующим символом:



Это означает, что нельзя смешивать электрические и электронные изделия с несортированными бытовыми отходами. НЕ пытайтесь разбирать систему самостоятельно: все операции по демонтажу системы, обработке хладагента, масла и других частей должны выполняться уполномоченным обслуживающим персоналом и в соответствии с действующим законодательством. Все детали должны быть переданы в специализированную организацию по утилизации для повторного использования, переработки и восстановления. Обеспечив надлежащую утилизацию этого продукта, вы поможете предотвратить возможные негативные последствия для окружающей среды и здоровья человека. Дополнительную информацию можно получить у обслуживающего персонала или в местных уполномоченных органах.

2 ВЗГЛЯД НА ПОЛЬЗОВАТЕЛЬСКИЙ ИНТЕРФЕЙС

2.1 Внешний вид проводного пульта управления

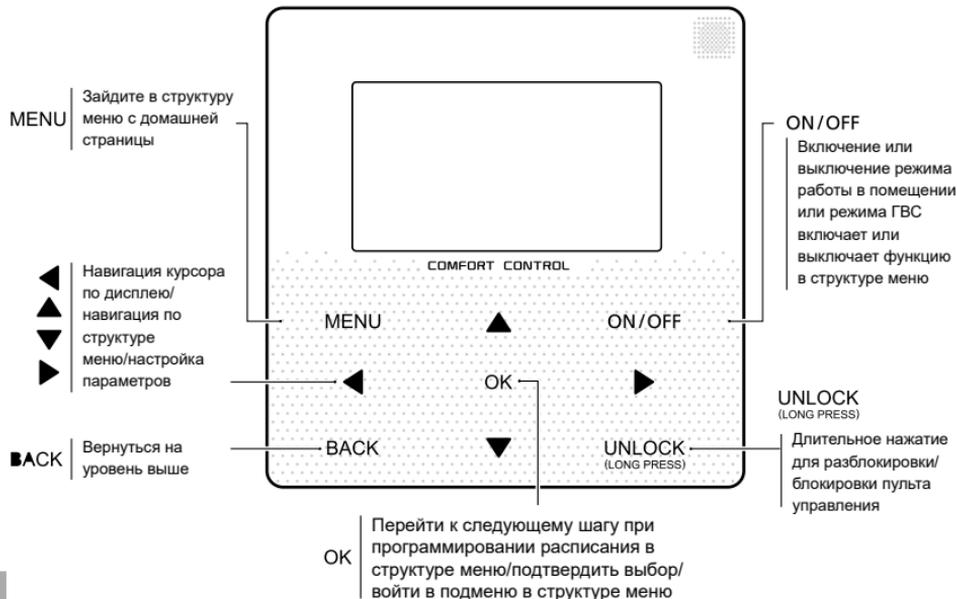

2.2 Значки состояния

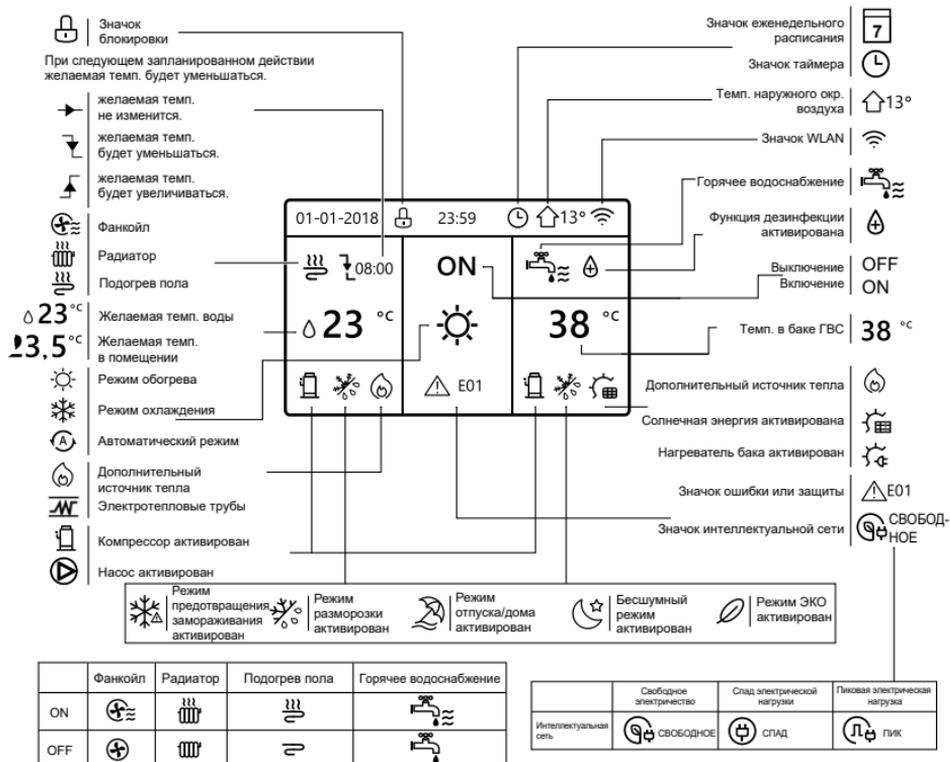

3 ИСПОЛЬЗОВАНИЕ ДОМАШНИХ СТРАНИЦ

3.1 О домашних страницах

Вы можете использовать домашние страницы для считывания и изменения настроек, предназначенных для ежедневного использования. Содержание и функции, которые можно увидеть и выполнить на домашних страницах, описаны в тех разделах руководства, где это применимо. В зависимости от компоновки системы могут быть доступны следующие домашние страницы:

- Желаемая температура в помещении (ПОМЕЩЕНИЕ)
- Желаемая температура воды (ГЛАВНАЯ)
- Фактическая температура в баке ГВС (БАК)

ГВС=горячее водоснабжение

домашняя страница 1:

Если параметр «ТЕМП. ВОДЫ» установлен равным «ДА» и параметр «ТЕМП. В ПОМЕЩЕНИИ» установлен равным «НЕТ» . В системе предусмотрена функция, которая включает подогрев пола и горячее водоснабжение, появится домашняя страница 1:

ПРИМЕЧАНИЕ.

Все рисунки в руководстве используются в целях пояснения, фактические страницы, отображаемые на экране, могут отличаться.

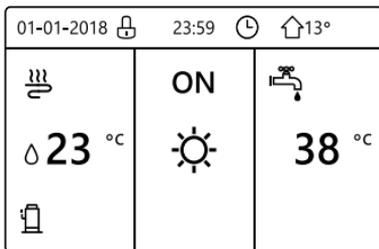

домашняя страница 2 :

Если параметр «ТЕМП. ВОДЫ» установлен равным «НЕТ» и параметр «ТЕМП. В ПОМЕЩЕНИИ» установлен равным «ДА» . В системе предусмотрена функция, которая включает подогрев пола и горячее водоснабжение, появится домашняя страница 2:

ПРИМЕЧАНИЕ.

Проводной пульт управления должен быть установлен в помещении с подогревом пола для проверки температуры в помещении.

01-01-2018  23:59   13°		
 23.5 °C 	ON 	 38 °C

домашняя страница 3:

Если «РЕЖИМ ГВС» установлен в состояние «НЕТ», и если параметр «ТЕМП. ВОДЫ» установлен равным «ДА», параметр «ТЕМП. В ПОМЕЩЕНИИ» установлен равным «ДА», появится домашняя страница и страница дополнения. Система имеет функцию, включающую подогрев пола и обогрев помещения для фанкойла, появится домашняя страница 3:

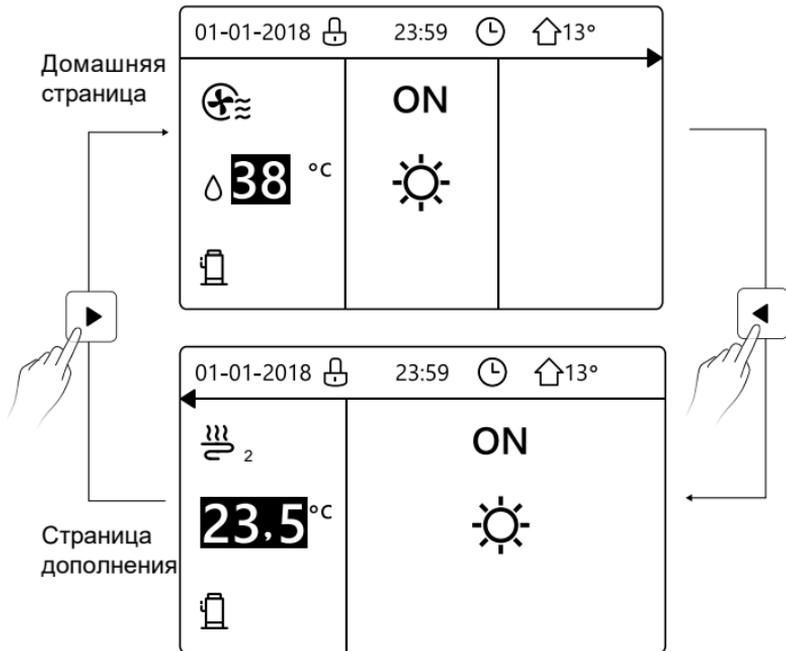

домашняя страница 4:

Если параметр «КОМНАТНЫЙ ТЕРМОСТАТ» установлен равным «ДВОЙНАЯ ЗОНА» или параметр «ДВОЙНАЯ ЗОНА» установлен в состояние «ДА», появится домашняя страница и страница дополнения. В системе предусмотрена функция охлаждения пола, охлаждения помещения для фанкойла и горячего водоснабжения, появится домашняя страница 4:

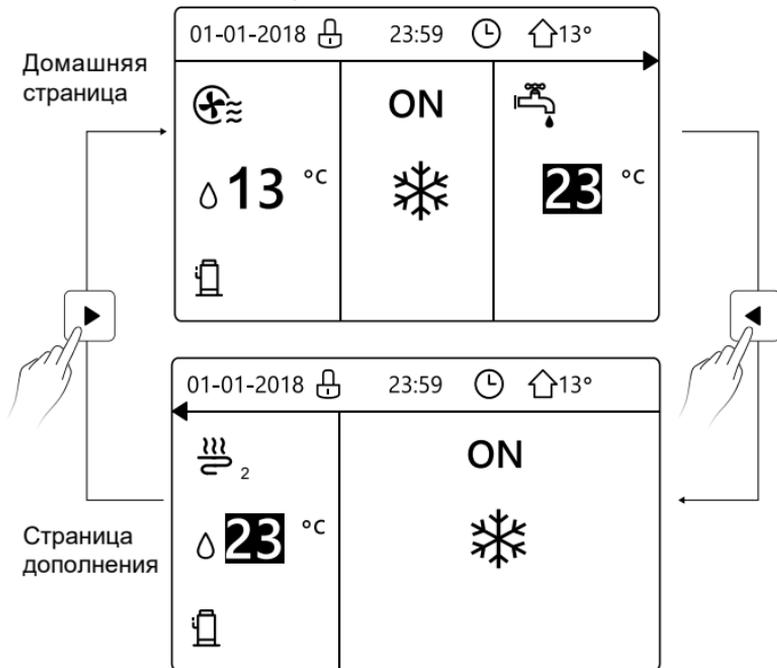

4 СТРУКТУРА МЕНЮ

4.1 Сведения о структуре меню

Вы можете использовать структуру меню для считывания и настройки тех параметров, которые НЕ предназначены для ежедневного использования. Содержание и функции, которые можно увидеть и выполнить с помощью структуры

4.2 Переход к структуре меню

На домашней странице нажмите «МЕНЮ». Результат: появляется структура меню:

МЕНЮ	1/2
РАБОЧИЙ РЕЖИМ	
ЗАДАН. ТЕМП.	
ГОР. ВОДОСНАБЖЕНИЕ (ГВС)	
РАСПИСАНИЕ	
НАСТРОЙКИ	
БЛОКИ. ОТ ДЕТЕЙ	
 ВВОД	

МЕНЮ	2/2
СПУЖЕБ	
РАБОЧИЙ ПАРАМЕТР	
ДЛЯ ТЕХОБСЛУЖ	
Настройка WLAN	
 ВВОД	

4.3 Навигация в структуре меню

Используйте «▼», «▲» для пролистывания.

5 ОСНОВНОЕ ИСПОЛЬЗОВАНИЕ

5.1 Разблокировка экрана

Если значок «» находится на экране, пульт управления заблокирован. Отображается следующая страница:

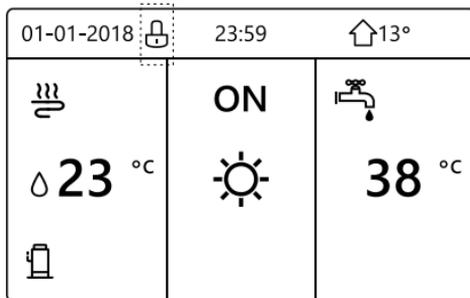

Нажмите любую клавишу, значок «» будет мигать. Нажмите и удерживайте клавишу «UNLOCK». Значок «» исчезнет, теперь с интерфейсом можно работать.

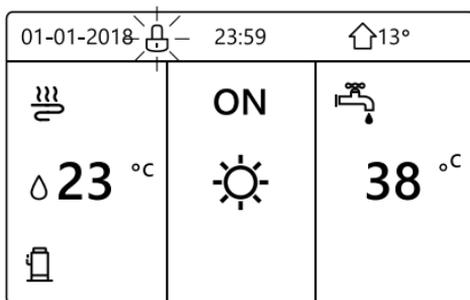

Интерфейс будет заблокирован, если работа с пультом не производится в течение длительного времени (около 120 секунд).

Если интерфейс разблокирован, нажмите и удерживайте клавишу «unlock», интерфейс будет заблокирован.

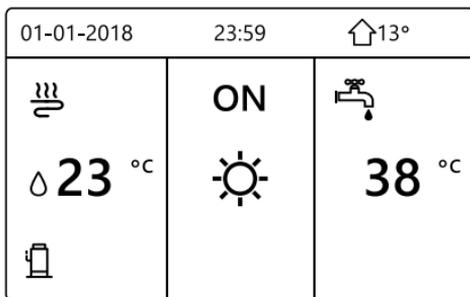

Длительное нажатие клавиши «UNLOCK»



Длительное нажатие клавиши «UNLOCK»

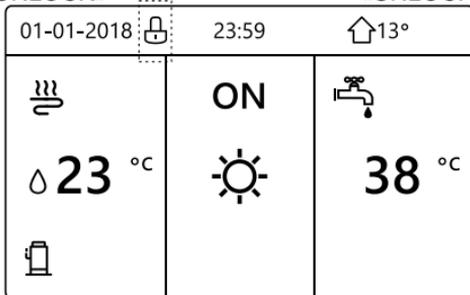

5.2 Органы управления включением/выключением ON/OFF

Используйте интерфейс для включения или выключения устройства для обогрева или охлаждения помещения.

- Функции включения/выключения устройства можно контролировать с интерфейса, если параметр «КОМНАТНЫЙ ТЕРМОСТАТ» установлен равным «НЕТ» (см. раздел «НАСТРОЙКА КОМНАТНОГО ТЕРМОСТАТА» в «Руководстве по установке и эксплуатации (внутренний блок сплит-системы M-thermal)»)
- Нажмите «◀», «▲» на домашней странице, появится черный курсор:

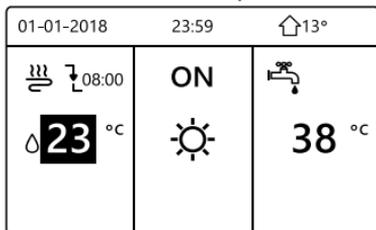

1) Когда курсор находится на стороне температуры для режима работы в помещении (включая режим обогрева ❄, режим охлаждения ☀- и автоматический режим (A)), нажмите клавишу «ON/OFF» для включения/выключения обогрева или охлаждения помещения.

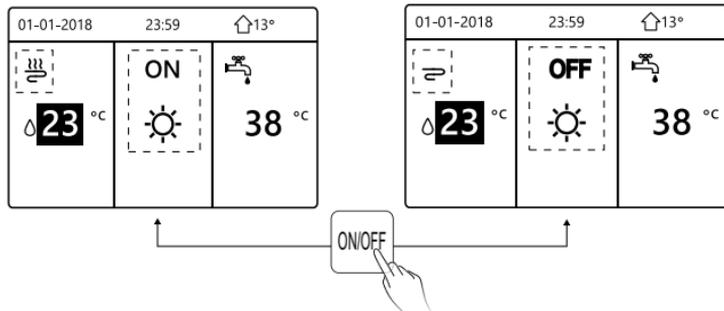

Если параметр «ТИП ГВС» установлен равным «НЕТ», появятся следующие страницы:

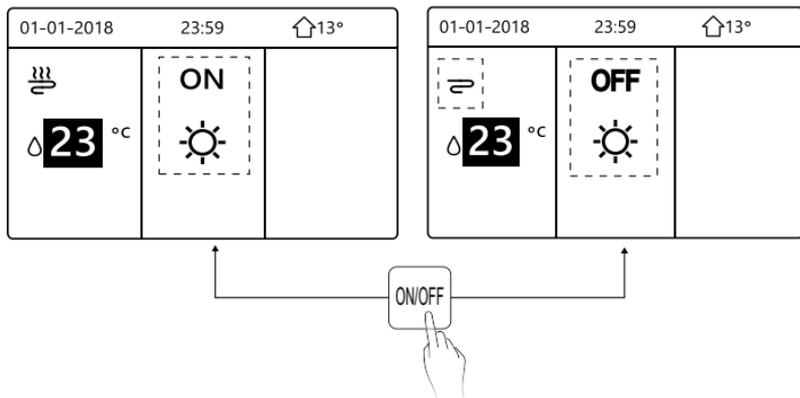

Если параметр «ТИП ТЕМП.» установлен равным «ТЕМП. В ПОМЕЩЕНИИ», появятся следующие страницы:

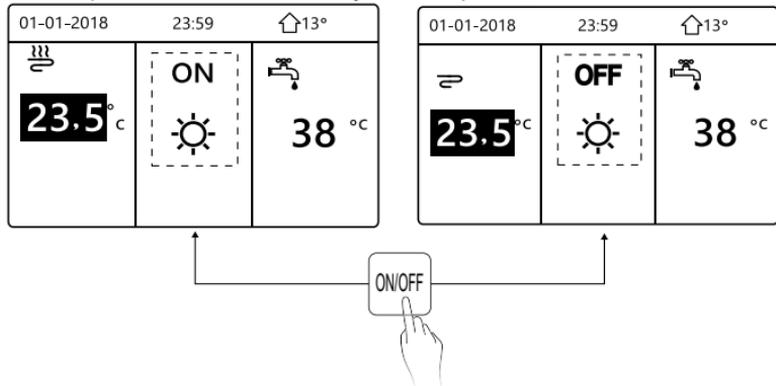

Используйте комнатный термостат для включения или выключения устройства для обогрева или охлаждения помещения.

① Комнатный термостат не находится в состоянии «НЕ НАСТРОЕН» (см. «НАСТРОЙКА КОМНАТНОГО ТЕРМОСТАТА» в «Руководстве по установке и эксплуатации (внутренний блок сплит-системы M-thermal)»). Устройство для обогрева или охлаждения помещения включается или выключается с помощью комнатного термостата, нажмите «ON/OFF» на интерфейсе, появится следующая страница:

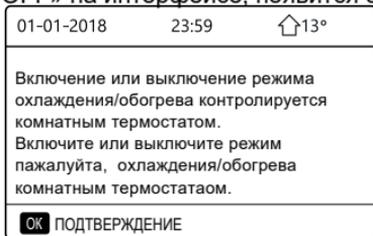

② Комнатный термостат настроен в режиме «НАСТРОИТЬ ДВОЙНУЮ ЗОНУ» (см. «НАСТРОЙКА КОМНАТНОГО ТЕРМОСТАТА» в «Руководстве по установке и эксплуатации (внутренний блок сплит-системы M-thermal)»). Комнатный термостат для фанкойла выключен, комнатный термостат для подогрева пола включен, устройство работает, но его дисплей выключен. Отображается следующая страница:

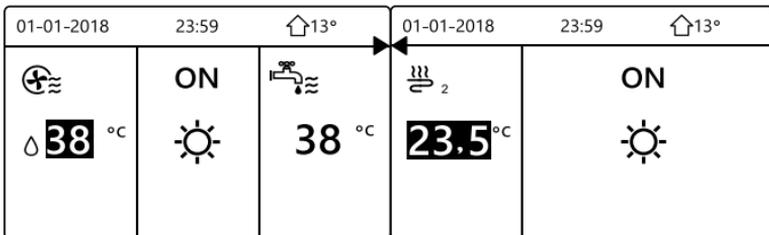

01-01-2018		23:59		🏠 13°		01-01-2018		23:59		🏠 13°	
⊕		OFF		🔧		⇌ 2		OFF			
Δ 38 °C		☀️		38 °C		23.5 °C		☀️			

Используйте интерфейс, чтобы включить или выключить устройство для ГВС. Нажмите «▶», «▼» на домашней странице, появится черный курсор:

01-01-2018		23:59		🏠 13°	
☁️		ON		🔧	
Δ 23 °C		☀️		38 °C	

2) Когда курсор будет находиться на температуре режима ГВС, нажмите клавишу «ON/OFF», чтобы включить/выключить режим ГВС. Если режим работы в помещении включен, отображаются следующие страницы:

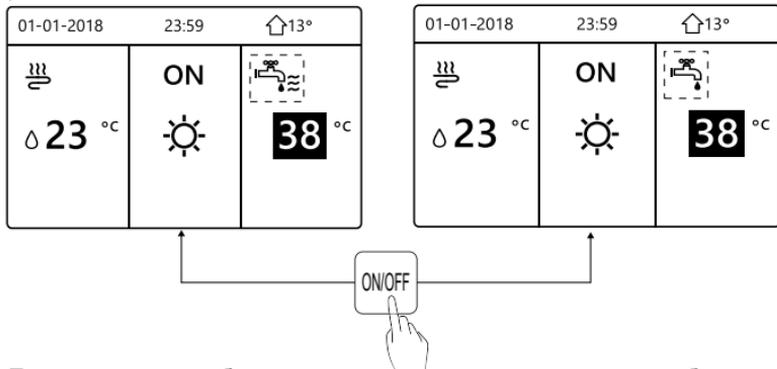

Если режим работы в помещении выключен, отображаются следующие страницы:

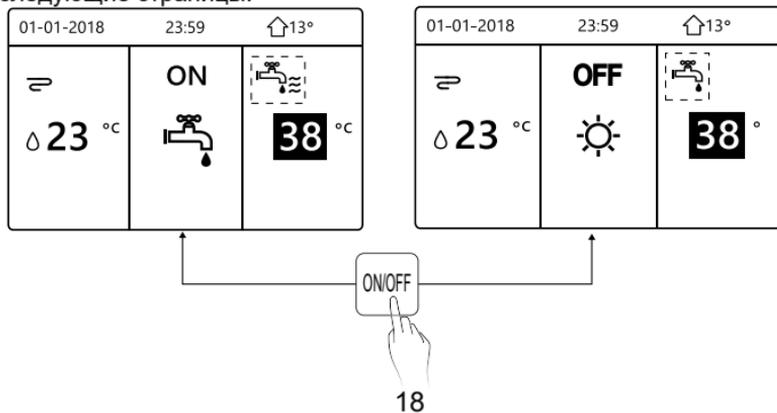

5.3 Регулировка температуры

Нажмите «◀», «▲» на домашней странице, появится черный курсор:

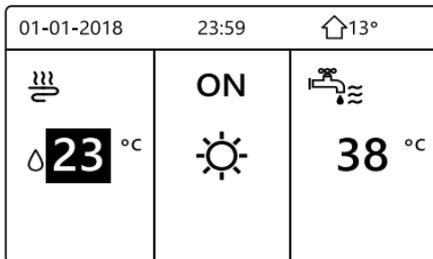

- Если курсор находится на температуре, используйте «◀», «▶», чтобы выбрать, и используйте «▼», «▲», чтобы отрегулировать температуру.

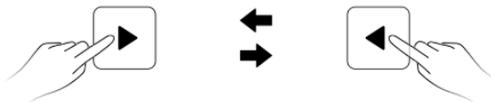
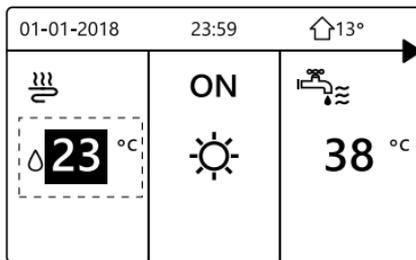

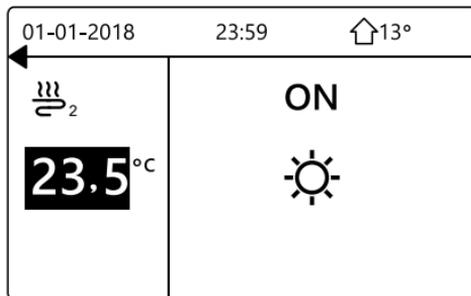
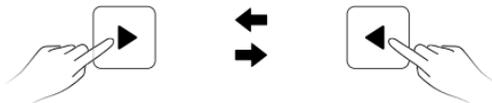
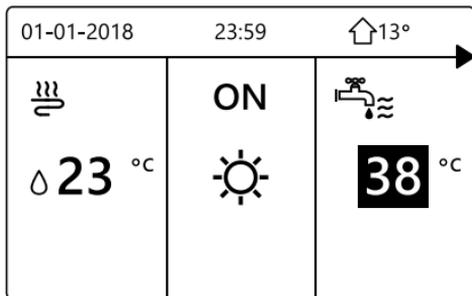

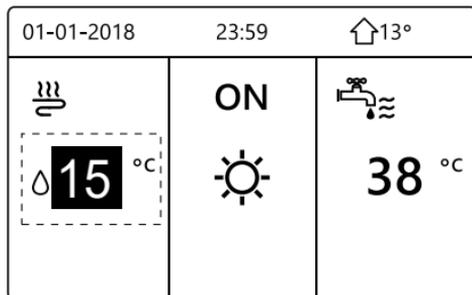
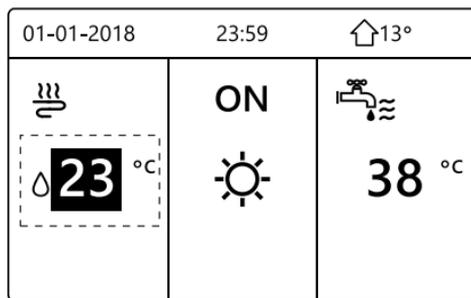

5.4 Регулировка режима работы в помещении

- Регулировка режима работы в помещении с помощью интерфейса. Перейдите в «МЕНЮ», «РЕЖИМ РАБОТЫ». Нажмите кнопку «ОК», появится следующая страница:



- Здесь можно выбрать три режима, включая режимы **ОБОГРЕВ**, **ОХЛАЖДЕНИЕ** и **АВТО**. Используйте «◀», «▶» для прокрутки, нажмите «ОК» для выбора. Если курсор был перемещен на рабочий режим, то этот режим все равно будет работать, даже если вы не нажмете кнопку «ОК» и не выйдете со страницы по нажатию кнопки «ВАСК».

Если есть только режим «ОБОГРЕВ» (ОХЛАЖДЕНИЕ), появится следующая страница:



- Режим работы не может быть изменен.

Если выбрать...	После этого режим работы в помещении...
 ОБОГРЕВ	Всегда только режим обогрева
 ОХЛАЖДЕНИЕ	Всегда только режим охлаждения
 АВТО	<p>Автоматически изменяется программным обеспечением в зависимости от температуры наружного воздуха (и в зависимости от настроек для температуры в помещении) и учитывает ежемесячные ограничения.</p> <p>Примечание. Автоматическое переключение возможно только при определенных условиях. См. раздел «ДЛЯ ОБСЛУЖИВАЮЩЕГО ПЕРСОНАЛА» > «НАСТРОЙКА АВТОМАТИЧЕСКОГО РЕЖИМА» в «Руководстве по установке и эксплуатации (внутренний блок сплит-системы M-thermal)».</p>

- Отрегулируйте режим работы в помещении с помощью комнатного термостата, см. «КОМНАТНЫЙ ТЕРМОСТАТ» в «Руководстве по установке и эксплуатации (внутренний блок сплит-системы M-thermal)».

Перейдите в «МЕНЮ» > «РЕЖИМ РАБОТЫ», если нажать любую клавишу для выбора или настройки, появится страница:

01-01-2018	23:59	 13°
охл/обогр. по термостату. Настройки рабочий режим через комнатный термостат.		
OK ПОДТВЕРЖДЕНИЕ		

6 Руководящие указания по настройке конфигурации сети

- Проводной контроллер обеспечивает возможность интеллектуального управления благодаря встроенному модулю, получающему командный сигнал от ПРИЛОЖЕНИЯ.
- Перед подключением сети WLAN убедитесь в наличии роутера в используемой среде, а также в том, что проводной контроллер надежно улавливает беспроводной сигнал.
- В процессе коммутирования беспроводного сигнала LCD-значок «» мигает, указывая на развертывание сети. После завершения процесса значок «» загорается постоянным светом.

6.1 Настройка проводного контроллера

Настройки проводного контроллера включают РЕЖИМ AP и ВОССТАНОВЛЕНИЕ НАСТРОЙКИ WLAN.

Настройка WLAN
AP РЕЖИМ
ВОССТ. НАСТР. WLAN
OK ВВОД 

- Активация WLAN через интерфейс. Перейдите в «МЕНЮ» > «НАСТРОЙКА WLAN» > «РЕЖИМ AP».

Нажмите «ОК», появится следующая страница:

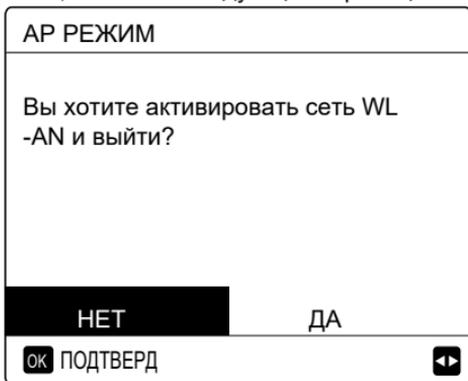

Используйте клавиши «◀» и «▶» для перемещения к варианту «ДА» и нажмите «ОК» для выбора режима AP. Аналогичным образом выберите режим AP на мобильном устройстве и продолжите процесс настройки в соответствии с инструкциями APP.



ВНИМАНИЕ!

При отсутствии подключения к мобильному телефону после перехода в режим AP LCD-значок «» будет мигать в течение 10 минут, а затем исчезнет.

При наличии подключения к мобильному телефону значок «» будет гореть постоянным светом.

- Восстановить настройку WLAN через интерфейс. Перейдите в «МЕНЮ» > «НАСТРОЙКА WLAN» > «ВОССТАНОВИТЬ НАСТРОЙКУ WLAN». Нажмите «ОК», появится следующая страница:

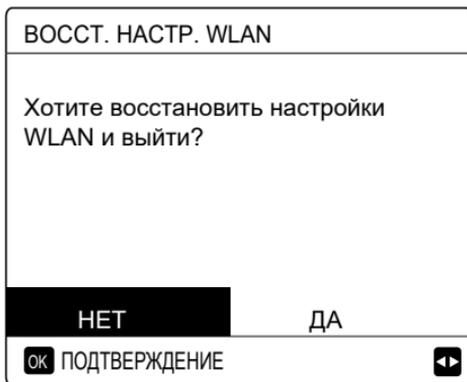

Используйте клавиши «◀» и «▶» для перемещения к варианту «ДА» и нажмите «ОК» для восстановления настройки WLAN. Завершите выполнение вышеуказанной операции и конфигурация беспроводной сети будет сброшена.

6.2 Настройка мобильного устройства

Режим AP доступен для коммутирования беспроводного сигнала со стороны мобильного устройства.

- Подключение WLAN через режим AP:

6.2.1 Установите ПРИЛОЖЕНИЕ

- ① Отсканируйте QR-код для установки приложения Smart Home APP.



- ② Выполните повторный поиск «MSmartLife» в APP STORE или GOOGLE PLAY для установки ПРИЛОЖЕНИЯ.

Это приложение применимо только к Android 7.0 и IOS7 или более новым операционным системам.

6.2.2 Вход в систему/регистрация

Пожалуйста, введите ваш регистрационный код. Или отсканируйте QR-код на упаковочной коробке контроллера, если он существует. И зарегистрируйте свой аккаунт в соответствии с указаниями.

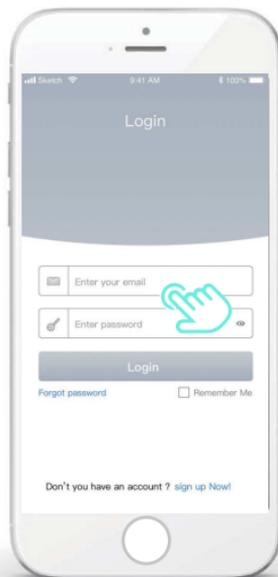
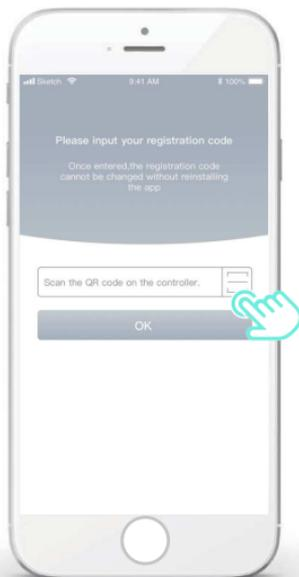

6.2.3 Добавить домашние устройства:

1) Добавьте свое устройство, следуя инструкциям.

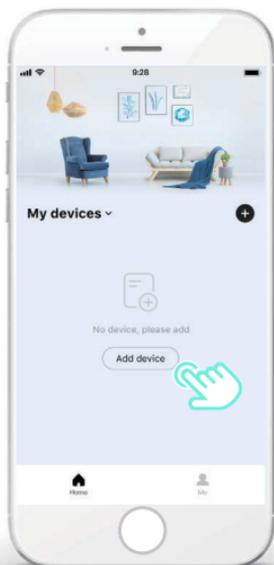

2) Следуйте указаниям APP.

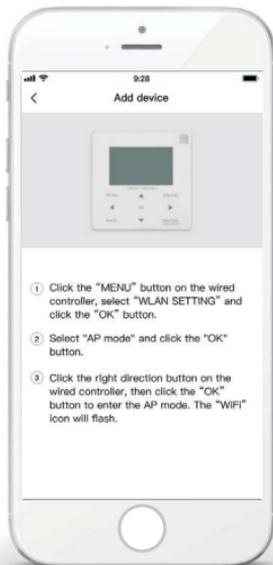

3) Дождитесь подключения домашнего устройства, а затем нажмите кнопку «Complete».

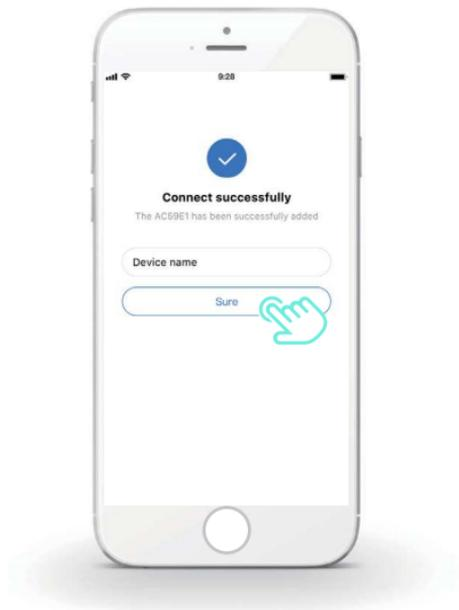

- 4) После успешного подключения устройства LCD-значок «» проводного контроллера будет гореть постоянным светом, и можно будет управлять кондиционером с помощью ПРИЛОЖЕНИЯ.
- 5) При сбое процесса подключения сети или поступлении запроса на переподключение или создание нового мобильного соединения выполните «Сброс Wi-Fi на заводские настройки» на проводном контроллере, а затем повторите вышеуказанный процесс.

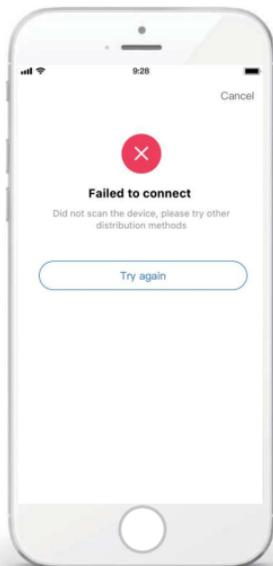



Предупреждение о сетевых сбоях / поиск и устранение неисправностей

Если устройство подключено к сети, убедитесь в том, что телефон находится как можно ближе к устройству.

В настоящее время мы обеспечиваем поддержку роутеров с частотным диапазоном только 2,4 ГГц.

Не рекомендуется использовать специальные символы (знаки пунктуации, пробелы и т. д.) в составе имени WLAN.

Рекомендуется не подключать к роутеру более 10 устройств во избежание получения домашними устройствами слабого или нестабильного сигнала.

При изменении пароля роутера или Wi-Fi сбросьте все настройки и перезапустите устройство.

Содержание ПРИЛОЖЕНИЯ может изменяться при обновлении версии, в остальном – работа выполняется в текущей версии.

7. РУКОВОДСТВО ПО УСТАНОВКЕ

7.1 Меры предосторожности, обеспечивающие безопасность

- Перед началом установки внимательно прочитайте о мерах предосторожности, обеспечивающих безопасность.
- Ниже изложены важные требования по безопасности, которые являются обязательными к выполнению.
- Убедитесь, что при тестовом запуске по завершении работ не наблюдается никаких отклонений, а затем передайте руководство пользователю.
- Значение символов:



ПРЕДУПРЕЖДЕНИЕ

Означает, что неправильное обращение с устройством может привести к смерти или тяжелой травме.



ВНИМАНИЕ!

Означает, что неправильное обращение с устройством может привести к травме или порче имущества.



ПРЕДУПРЕЖДЕНИЕ

Доверьте установку устройства дистрибьютору или профессиональному обслуживающему персоналу.

Осуществление установки иными лицами может привести к неправильной установке, поражению электрическим током или пожару.

В точности следуйте данному руководству.

Неправильная установка может привести к поражению электрическим током или пожару.

Повторная установка должна выполняться профессионалами.

Неправильная установка может привести к поражению электрическим током или пожару.

Не разбирайте кондиционер по собственному желанию.

Случайная разборка может привести к неполадкам в работе или избыточному нагреву, что может закончиться пожаром.



ВНИМАНИЕ!

Не устанавливайте устройство в местах, где может произойти утечка легковоспламеняющихся газов.

В случае утечки и скопления легковоспламеняющихся газов вокруг проводного пульта управления может начаться пожар.

Проводка должна соответствовать напряжению проводного пульта управления.

В противном случае может произойти утечка тока и перегрев, которые спровоцируют возгорание.

Для прокладки проводки должны использоваться указанные кабели. На разъемы не должно оказываться внешнее воздействие.

В противном случае может произойти короткое замыкание и перегрев, которые спровоцируют возгорание.

Пульт дистанционного управления запрещено размещать рядом с лампами, чтобы избежать прерывания удаленного сигнала пульта (см. рисунок справа)



7.2 Прочие меры предосторожности

7.2.1 Место установки

Не устанавливайте устройство в местах, где может скапливаться масло, пары или сернистые газы.

Это может привести к деформации устройства и его выходу из строя.

7.2.2 Подготовка перед установкой

1) Убедитесь в том, что следующие узлы присутствуют в полной комплектации.

№	Наименование	Кол-во	Примечания
1	Проводной пульт управления	1	_____
2	Деревянный монтажный винт с полукруглой головкой под крестообразный шлиц	3	Для установки на стену
3	Монтажный винт с полукруглой головкой под крестообразный шлиц	2	Для установки на электрическую распределительную коробку
4	Руководство по установке и руководство для владельца	1	_____
5	Пластиковый болт	2	Данное приспособление необходимо для установки централизованного управления в электрический щит
6	Пластиковая компенсационная труба	3	Для установки на стену

7.2.3 Примечания по установке проводного пульта управления:

- 1) Данное «Руководство по установке» содержит информацию о процедуре установки проводного пульта дистанционного управления. Информация по обеспечению связи между проводным пультом дистанционного управления и внутренним блоком изложена в «Руководстве по установке внутреннего блока».
- 2) Цепь проводного пульта дистанционного управления является цепью низкого напряжения. Никогда не подключайте ее к стандартной цепи 220 В / 380 В и не закладывайте в одну и ту же трубу для прокладки коммуникаций вместе с цепью.
- 3) Экранированный кабель следует надежно закрепить на уровне грунта, иначе произойдет сбой передачи.
- 4) Не пытайтесь удлинить экранированный кабель, обрезая его, при необходимости используйте клеммную колодку.
- 5) Установив соединение, используйте мегомметр для проверки изоляции сигнального провода.

7.3 Процедура установки и настройка проводного пульта управления

7.3.1 Изображение с размерами конструкции

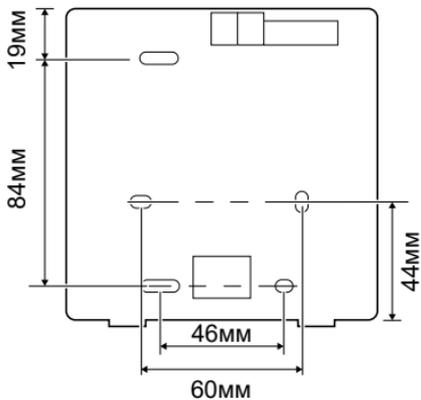
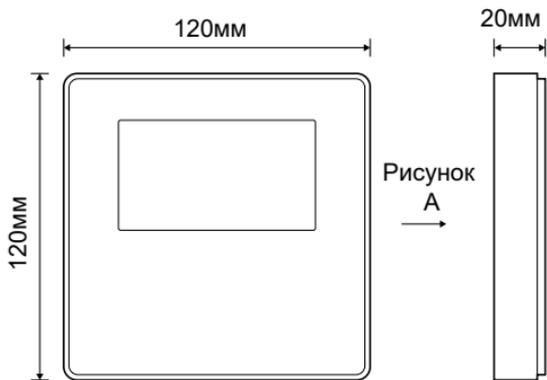

7.3.2 Проводка

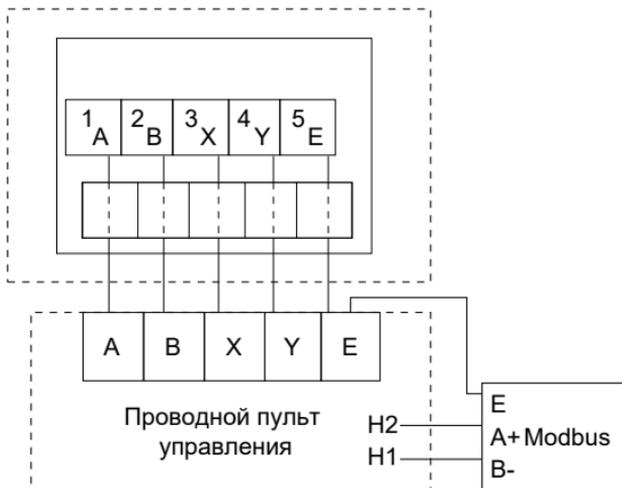

Входное напряжение (A/B)	13,5 VAC
Размеры проводки	0,75 мм ²

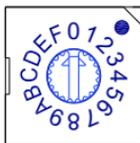

Вращающийся кодовый переключатель S3 (0-F) на главной панели управления гидравлического модуля используется для того, чтобы задать адрес Modbus. По умолчанию кодовый переключатель у данных устройств находится в положении = 0, но оно совпадает с адресом 16 Modbus, в то время как остальные позиции соотносятся с номером, например, pos = 2 – это адрес 2, pos = 5 – это адрес 5.

7.3.3 Установка задней крышки

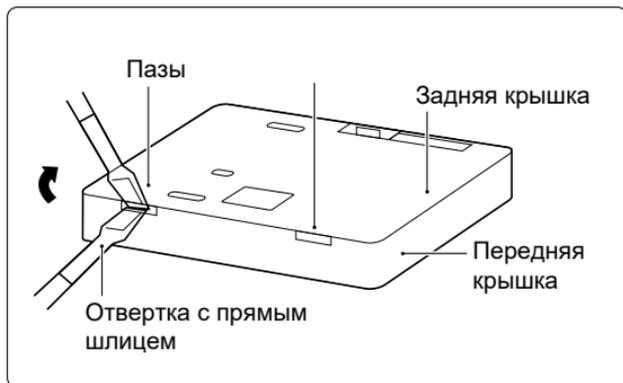

Отверстие под винт, закрепляется
тремя винтами М4Х20

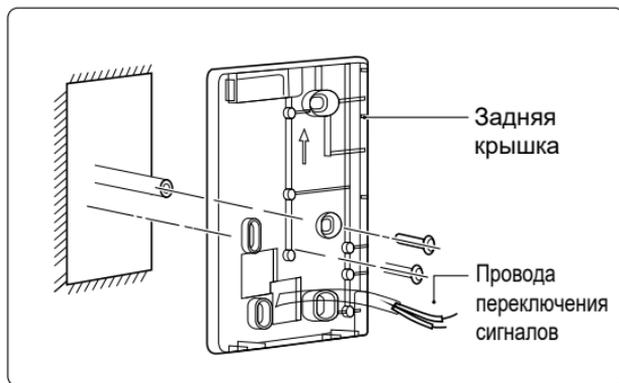

- 1) Вставьте отвертку с прямым шлицем в пазы в нижней части проводного пульта управления и поверните ее, чтобы снять заднюю крышку (обратите внимание на направление вращения, иначе вы повредите заднюю крышку).
- 2) Чтобы закрепить заднюю крышку непосредственно на стене, используйте три винта М4Х20.
- 3) Используйте два винта М4Х25, чтобы закрепить заднюю крышку на распределительной коробке 86, и один винт М4Х20 для крепления на стену.
- 4) Отрегулируйте длину пластиковых шпилек, входящих в комплект поставки, чтобы их длина соответствовала расстоянию от шпилек распределительной коробки до стены. При установке шпилек в стену убедитесь в том, что они не выступают из плоскости стены.
- 5) Используйте винты с крестообразной головкой, чтобы закрепить нижнюю крышку проводного пульта управления в стене с помощью шпильки. Убедитесь в том, что нижняя крышка проводного пульта управления после установки находится на том же уровне, а затем установите проводной пульт управления обратно на нижнюю крышку.
- 6) Излишняя затяжка винта приведет к деформации задней крышки.

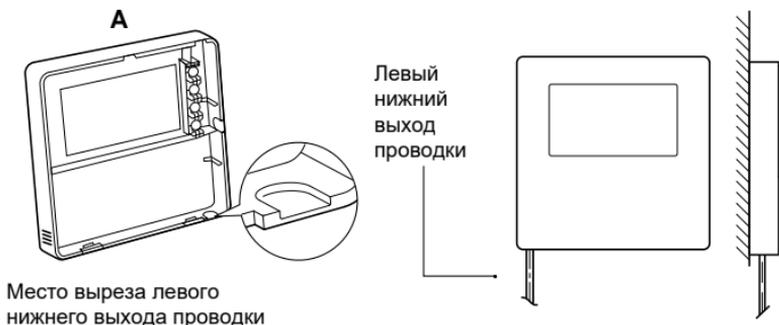

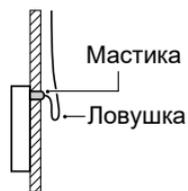
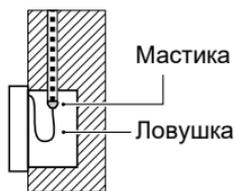
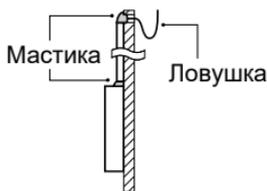
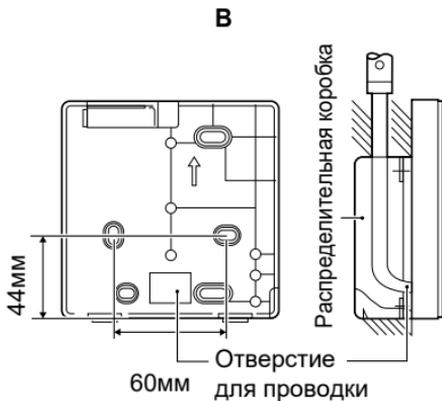

Избегайте попадания воды в проводной пульт дистанционного управления, во время монтажа проводки используйте ловушки и мастику для герметизации разъемов проводов.

7.4 Установка передней крышки

Отрегулируйте переднюю крышку, а затем закройте ее; во время установки избегайте зажимания провода переключения связи.

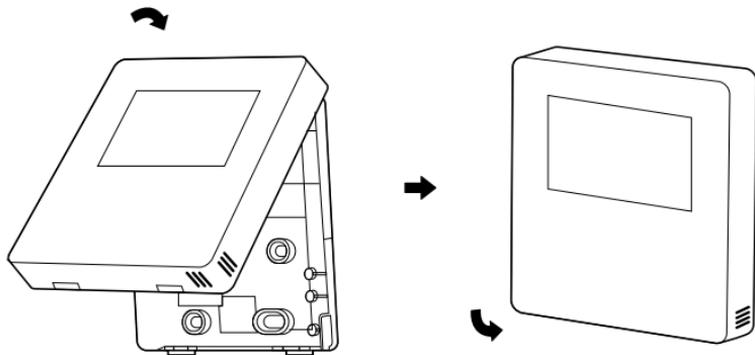

Повышенная влажность не оказывает влияния на датчик.

Правильно установите заднюю крышку и надежно закрепите переднюю крышку на задней крышке во избежание ее падения.



